

Toggles

Rockers

Pushbuttons

Programmable Illuminated PB

Keylocks

Rotaries

Slides **H**

Tactiles

Tilt

Touch

Indicators

Accessories

Supplement



AS Series H4

0.4VA Logic Level
Straight, Right Angle & Vertical PC



CS Series H10

3A Power Level
Straight PC
PCB Mount



FS Series H14

High Frequency
90MHz to 1GHz
Straight PC



JS01, JS03 Series H18

Extended & Piano Actuated DIP Slides
25mA @ 24V DC
Straight PC



JS02, JS04 SMT Series H24

Ultra-miniature 25mA DIP Slide
Gull Wing Terminals
4- & 8-position



MS Series H30

6A Power Level & 0.4VA Logic Level
 Solder Lug, Straight PC, Right Angle & Vertical PC
 Panel Mount, PCB Mount, & Bracket Mount



MS Illuminated Series H38

6A Power Level
 LED Illumination
 Solder Lug & Straight PC
 PCB Mount & Flat Frame Mount



SM Series H42

Ultra-miniature
 500mA or 1.0mA
 Straight PC



SS Series H44

0.1A Power Level & 0.4VA Logic Level
 Top & Side Actuated
 PCB Mount



SS Illuminated Series H49

0.1A Power Level
 LED Illumination
 Top & Side Actuation
 PCB Mount



SS3 SMT Series H53

Ultra-miniature 0.4VA Logic Level
 Side Actuated

Toggle

Rockers

Pushbuttons

Illuminated PB

Programmable

Keylocks

Rotaries

H
Slides

Tactiles

Tilt

Touch

Indicators

Accessories

Supplement

General Specifications

Electrical Capacity (Resistive Load)

Logic Level: 0.4VA maximum @ 28V AC/DC maximum
(Applicable Range 0.1mA ~ 0.1A @ 20mV ~ 28V)
Note: Find additional explanation of operating range in Supplement section.

Other Ratings

Contact Resistance: 50 milliohms maximum
Insulation Resistance: 500 megohms minimum @ 500V DC
Dielectric Strength: 500V AC minimum for 1 minute minimum
Mechanical Life: 50,000 operations minimum
Electrical Life: 50,000 operations minimum
Nominal Operating Force: 2.55N
Contact Timing: Nonshorting (break-before-make)
Travel: Pretravel: .082" (2.1mm); Overtravel: .016" (0.4mm); Total Travel: .098" (2.5mm)

Materials & Finishes

Actuator: Glass fiber reinforced polyamide
Upper Case Housing: Carbon blended polyacetal (antistatic)
Lower Case Housing: Glass fiber reinforced polyamide
Support Bracket: Tin plated phosphor bronze
Movable Contact: Phosphor bronze with gold plating
Stationary Contacts: Brass with gold plating
Terminals: Brass with gold plating

Environmental Data

Operating Temperature Range: -30°C through +85°C (-22°F through +185°F)
Humidity: 90 ~ 95% humidity for 192 hours @ 40°C (104°F)
Vibration: 10 ~ 60Hz with peak-to-peak amplitude of 1.5mm traversing the frequency range & returning in 5 minutes; 3 right angled directions for 30 minutes
Shock: 50G (490m/s²) acceleration (tested in 6 right angled directions, with 5 shocks in each direction)

PCB Processing

Soldering: Wave Soldering Recommended. See Profile A in Supplement section.
Manual Soldering: for single pole see Profile B in Supplement section; for double pole see Profile A.
Cleaning: These devices are not process sealed. Hand clean locally using alcohol based solution.

Standards & Certifications

The A Series slides have not been tested for UL recognition or CSA certification. These switches are designed for use in a low-voltage, low-current, logic-level circuit. When used as intended in a logic-level circuit, the results do not produce hazardous energy.

Toggles

Rockers

Pushbuttons

Programmable Illuminated PB

Keylocks

Rotaries

Slides

Tactiles

Tilt

Touch

Indicators

Accessories

Supplement

Distinctive Characteristics

Subminiature size (1/3 size of Series M switches) saves space on PC boards.

Specifically developed for logic-level applications.

Award-winning STC contact mechanism with benefits unavailable in conventional mechanisms: smoother, positive detent actuation, increased contact stability and unparalleled logic-level reliability. (Additional STC details in Terms & Acronyms; see Supplement section.)

Available in various actuator lengths.

Antistatic superstructure of carbon blended polyacetal prevents static discharge to the contacts.

Molded-in, epoxy sealed or ultrasonically welded terminals lock out flux, solvents, and other contaminants.

.100" x .100" (2.54mm x 2.54mm) terminal spacing conforms to standard PC board grid spacing.

Matching indicators available.

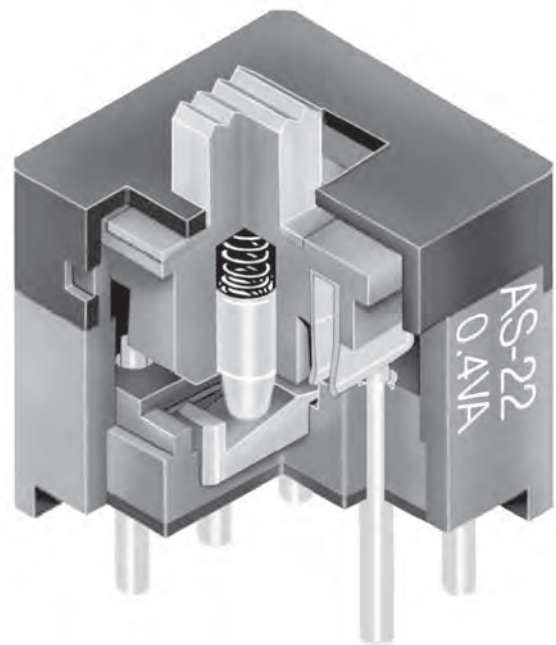

Actual Size

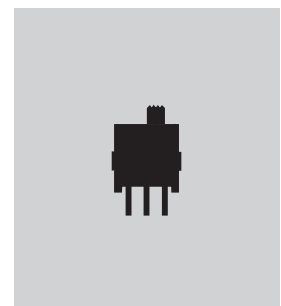

TYPICAL SWITCH ORDERING EXAMPLE

AS **2** **2** **A** **H**

Poles		Circuits				Actuators		PC Terminals	
1	SPST SPDT	1	ON	NONE	OFF	A	.098" (2.5mm) Long	P	Straight
2	DPDT SP3T	2	ON	NONE	ON	B	Flush	*B	Straight with Bracket
		3	ON	OFF	ON	C	.150" (3.8mm) Long	*H	Right Angle with Bracket
		4	ON	ON	ON			*V	Vertical with Bracket

*Bracketed models are ESD protected

DESCRIPTION FOR TYPICAL ORDERING EXAMPLE

AS22AH



DPDT
ON-NONE-ON Circuit

.098" (2.5mm) Long Actuator



Right Angle PC Terminals

POLES & CIRCUITS

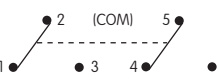
Pole	Model	Slide Position			Connected Terminals			Throw & Schematics
		Left	Center	Right	Left	Center	Right	
SP	AS11	ON	NONE	OFF	3-1	OPEN	OPEN	SPST 
SP	AS12 AS13	ON ON	NONE OFF	ON ON	2-1 2-1	OPEN OPEN	2-3 2-3	SPDT 
DP	AS22 AS23	ON ON	NONE OFF	ON ON	2-1 5-4 2-1 5-4	OPEN OPEN	2-3 5-6 2-3 5-6	DPDT 

Note: Terminal numbers are not actually on the switch.

For 3 Throw (3-On)

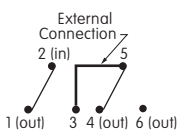
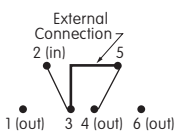
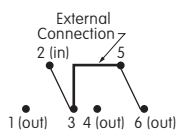
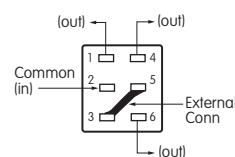
Pole	Model	Connected Terminals & Schematics			External Connection
		Left	Center	Right	
SP	AS24	ON  2-1 5-4	ON  2-3 5-4	ON  2-3 5-6	The SP3T model utilizes a double pole base. External connections must be made during field installation. 

ACTUATORS

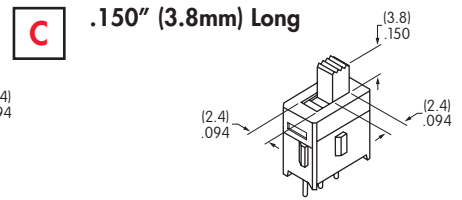
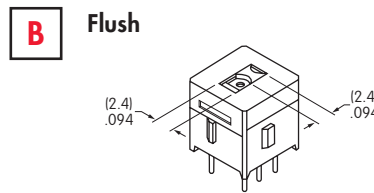
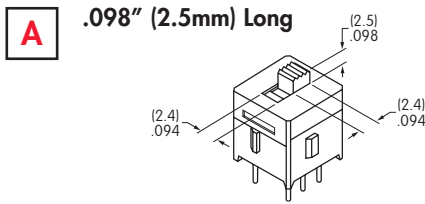

Actuator Color: Gray standard; contact factory for other colors.

PC TERMINALS

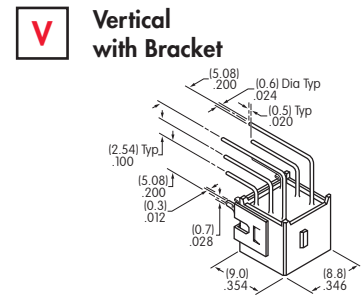
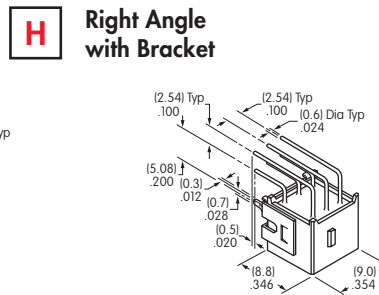
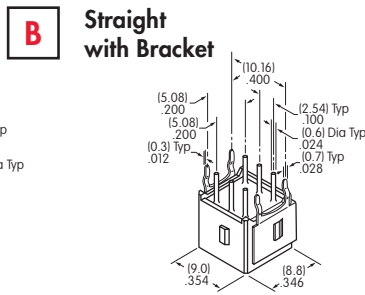
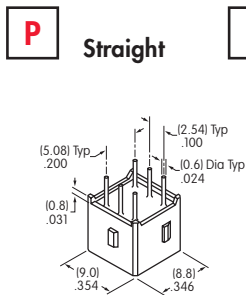

Use of a support bracket is recommended to increase PCB mounting strength and stability.

TYPICAL SWITCH DIMENSIONS

Single Pole

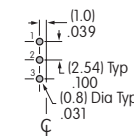
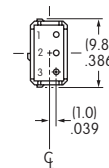
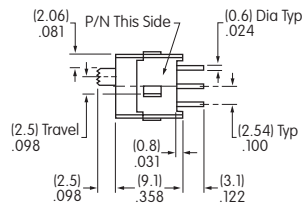
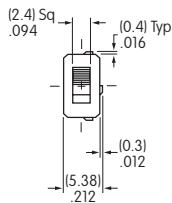

Actuator shown in LEFT position

Single throw models do not have terminal 2.

Straight PC



AS12AP

Double Pole

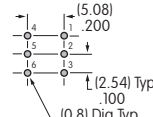
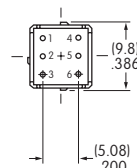
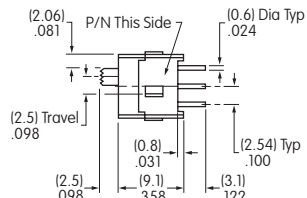
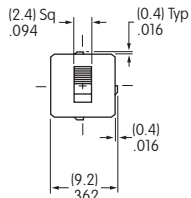

Actuator shown in LEFT position

Straight PC



AS22AP

Single Pole

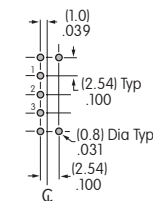
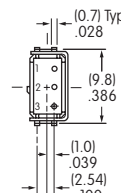
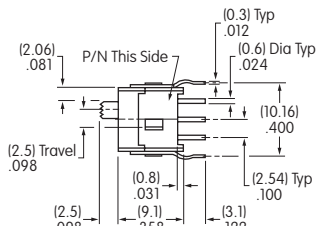
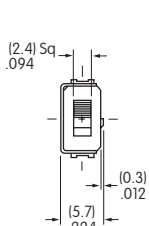

Actuator shown in LEFT position

Straight PC • Bracket



AS12AB

TYPICAL SWITCH DIMENSIONS

Straight PC • Bracket

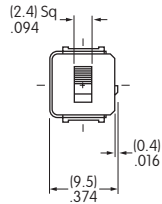

AS22AB

Double Pole

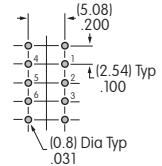
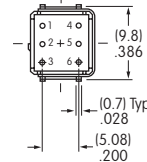
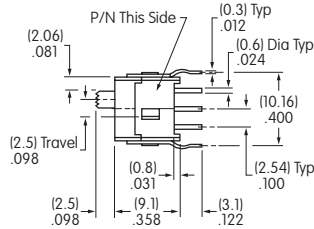

Actuator shown in LEFT position

Right Angle PC

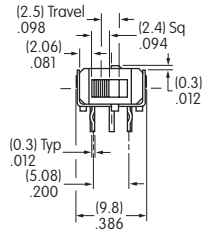

AS12AH

Single Pole

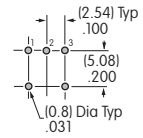
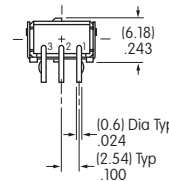
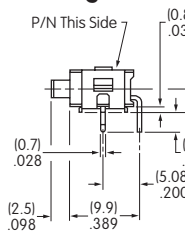

Actuator shown in LEFT position

Right Angle PC

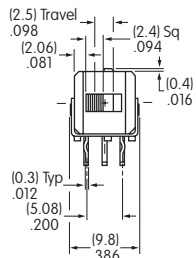

AS22AH

Double Pole

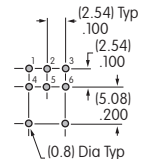
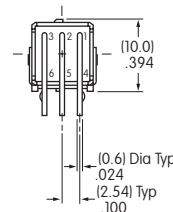
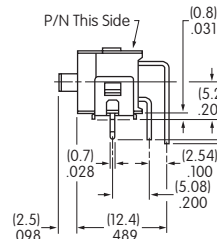

Actuator shown in LEFT position

Vertical PC

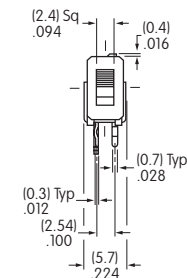

AS12AV

Single Pole

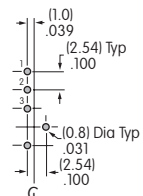
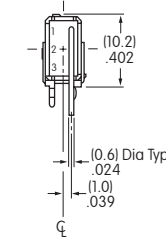
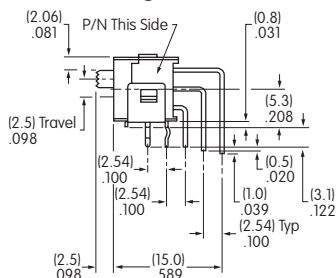

Actuator shown in LEFT position

Vertical PC

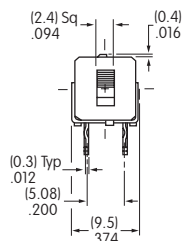

AS22AV

Double Pole

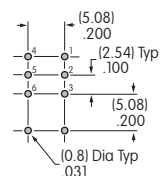
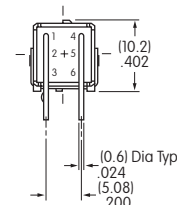
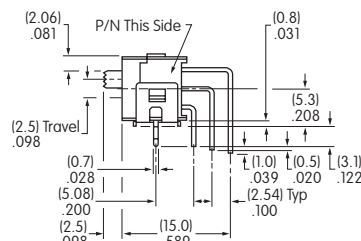

Actuator shown in LEFT position

Toggles
Rockers
Pushbuttons
Illuminated PB
Keylocks
Rotaries
Slides
Tactiles
Tilt
Touch
Indicators
Accessories
Supplement

Toggles

Rockers

Pushbuttons

Illuminated PB

Programmable

Keylocks

Rotaries

Slides

Tactiles

Tilt

Touch

Indicators

Accessories

Supplement

General Specifications

Electrical Capacity (Resistive Load)

Power Level: 3A @ 125V AC or 2A @ 250V AC

Other Ratings

Contact Resistance: 10 milliohms maximum

Insulation Resistance: 1,000 megohms minimum @ 500V DC

Dielectric Strength: 1,000V AC minimum between contacts for 1 minute minimum;
1,500V AC minimum between contacts & case for 1 minute minimum

Mechanical Life: 50,000 operations minimum

Electrical Life: 20,000 operations minimum

Static Capability: Withstands 12 kilovolts ESD

Contact Timing: Nonshorting (break-before-make)

Total Travel: .087" (2.2mm)

Materials & Finishes

Actuator: Glass fiber reinforced polyamide

Cover & Case: Glass fiber reinforced polyamide (UL94V-0)

Movable Contacts: Copper with silver plating

Stationary Contacts: Silver capped copper with silver plating

Terminals: Copper with silver plating

Environmental Data

Operating Temp Range: -30°C through +85°C (-22°F through +185°F)

Humidity: 90 ~ 95% humidity for 240 hours @ 40°C (104°F)

Vibration: 10 ~ 55Hz with peak-to-peak amplitude of 1.5mm traversing the frequency range & returning in 1 minute; 3 right angled directions for 2 hours

Shock: 50G (490m/s²) acceleration (tested in 6 right angled directions, with 5 shocks in each direction)

Installation

Soldering Time & Temp: Wave Soldering: See Profile A in Supplement section.

Manual Soldering: See Profile B in Supplement section.

Cleaning: These devices are not process sealed. Hand clean locally using alcohol based solution.

Standards & Certifications

Flammability Standard: UL94V-0 cover & case

Distinctive Characteristics

High performance and high quality at a low price.

Molded cover and case of high insulating material withstand 12 kilovolts of electrostatic discharge (ESD), providing antistatic feature.

Cover and case UL 94V-0 flammability rated.

Epoxy sealed terminals to lock out flux, dust, and other contaminants.

Suited for a wide variety of applications including telecommunications, electronic controls, audio devices, and household appliances.

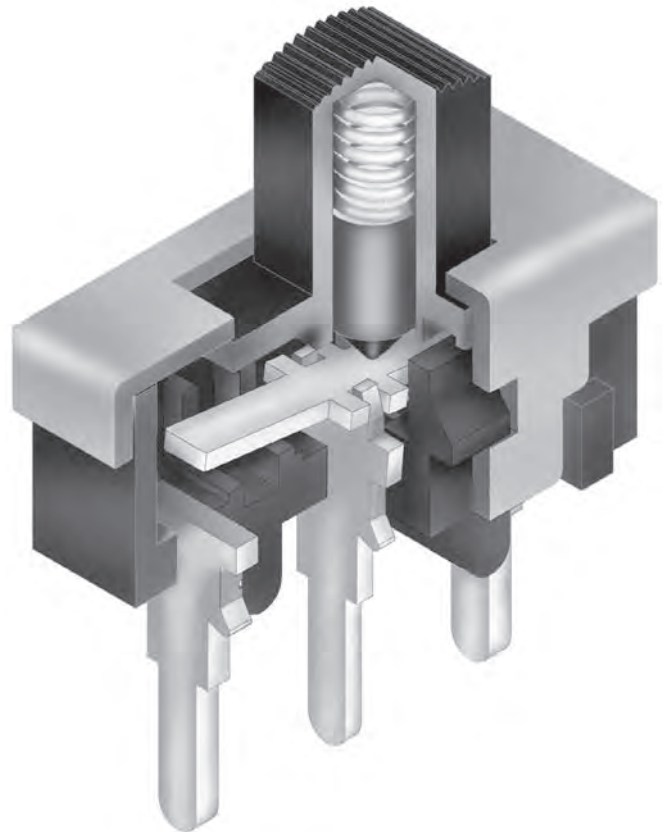

Actual Size

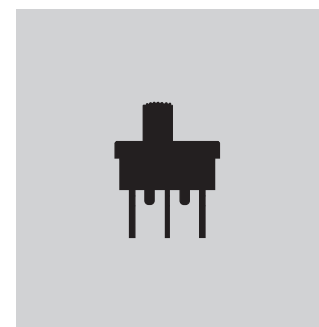

- Supplement
- Accessories
- Indicators
- Touch
- Tilt
- Tactiles
- H Slides**
- Rotaries
- Key locks
- Programmable
- Illuminated PB
- Pushbuttons
- Rockers
- Toggle

TYPICAL SWITCH ORDERING EXAMPLE

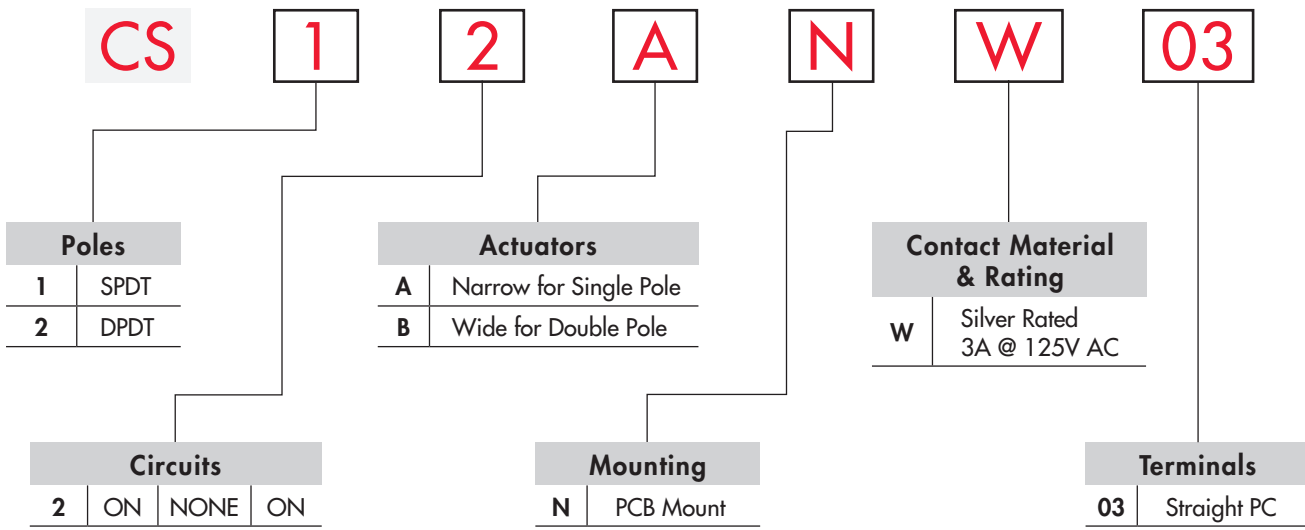

DESCRIPTION FOR TYPICAL ORDERING EXAMPLE

CS12ANW03

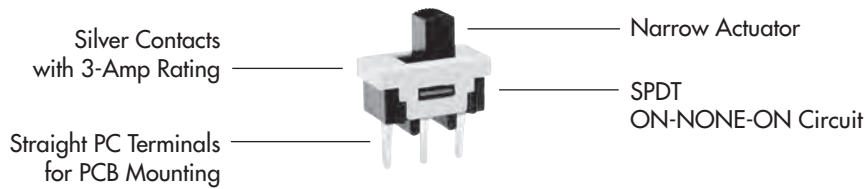

POLES & CIRCUITS

Pole	Model	Slide Position			Connected Terminals			Throw & Schematics
		Left	Center	Right	Left	Center	Right	
SP	CS12	ON	NONE	ON	2-1	OPEN	2-3	SPDT
DP	CS22	ON	NONE	ON	2-1 5-4	OPEN	2-3 5-6	DPDT

Note: Terminal numbers are not actually on switch.

MOUNTING

Panel Cutouts

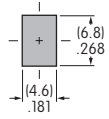

Single Pole

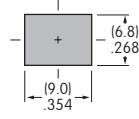

Double Pole

PCB Footprints

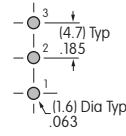

Single Pole

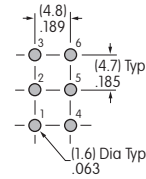

Double Pole

TYPICAL SWITCH DIMENSIONS

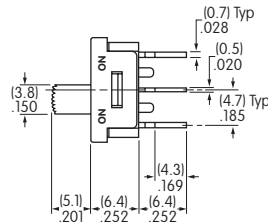
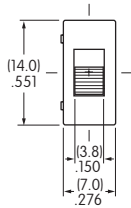

Actuator shown in LEFT position

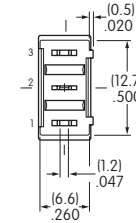

Single Pole



CS12ANW03

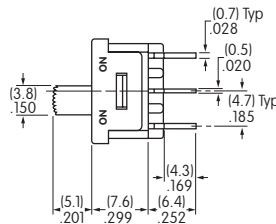
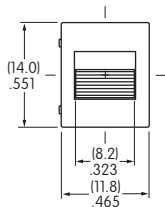

Actuator shown in LEFT position

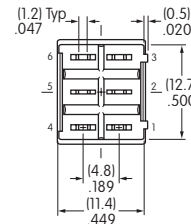

Double Pole



CS22BNW03

General Specifications

For high frequency (DC through 1GHz): Isolation 40dB minimum at 1GHz.
Insertion loss 0.5dB maximum at 1GHz.

Impedance 75 ohms

Innovative alternative to relay products

Highly reliable, self-cleaning twin contact mechanism with gold plating

Long total travel of .138" (3.5mm) for highly visible actuator position

Distinct audible and tactile feedback during actuation

Suited to high frequency applications (90MHz to 1GHz) such as CATV and communication equipment

Actual Size
with Tall Actuator

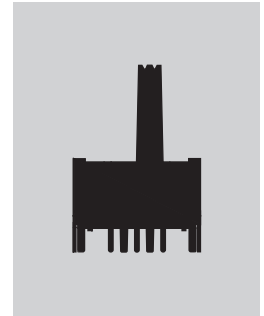

Distinctive Characteristics

Electrical Capacity (Resistive Load)

Logic Level: 0.4VA maximum @ 28V AC/DC maximum
(Applicable Range 0.1mA ~ 0.1A @ 20mV ~ 28V)
Note: Find additional explanation of operating range in Supplement section.

RF Ratings

Impedance: 75 ohms
Insertion Loss: 0.5dB maximum @ 1GHz
Isolation: 40dB minimum @ 1GHz

Other Ratings

Contact Resistance: 200 milliohms maximum
Insulation Resistance: 250 megohms minimum @ 500V DC
Dielectric Strength: 500V AC minimum for 1 minute minimum
Mechanical Life: 1,000 operations minimum
Electrical Life: 1,000 operations minimum
Contact Timing: Nonshorting (break-before-make)
Total Travel: .138" (3.5mm)

Environmental Data

Operating Temp Range: -30°C through +85°C (-22°F through +185°F)
Humidity: 90 ~ 95% humidity for 240 hours @ 40°C (104°F)
Vibration: 10 ~ 55Hz with peak-to-peak amplitude of 1.5mm traversing the frequency range & returning in 5 minutes; 3 right angled directions for 2 hours
Shock: 50G (490m/s²) acceleration (tested in 6 right angled directions, with 5 shocks in each direction)

Installation

Soldering Time & Temp: Wave Soldering: See Profile A in Supplement section.
Manual Soldering: See Profile A in Supplement section.
Cleaning: These devices are not process sealed. Hand clean locally using alcohol based solution.

TYPICAL SWITCH ORDERING EXAMPLE

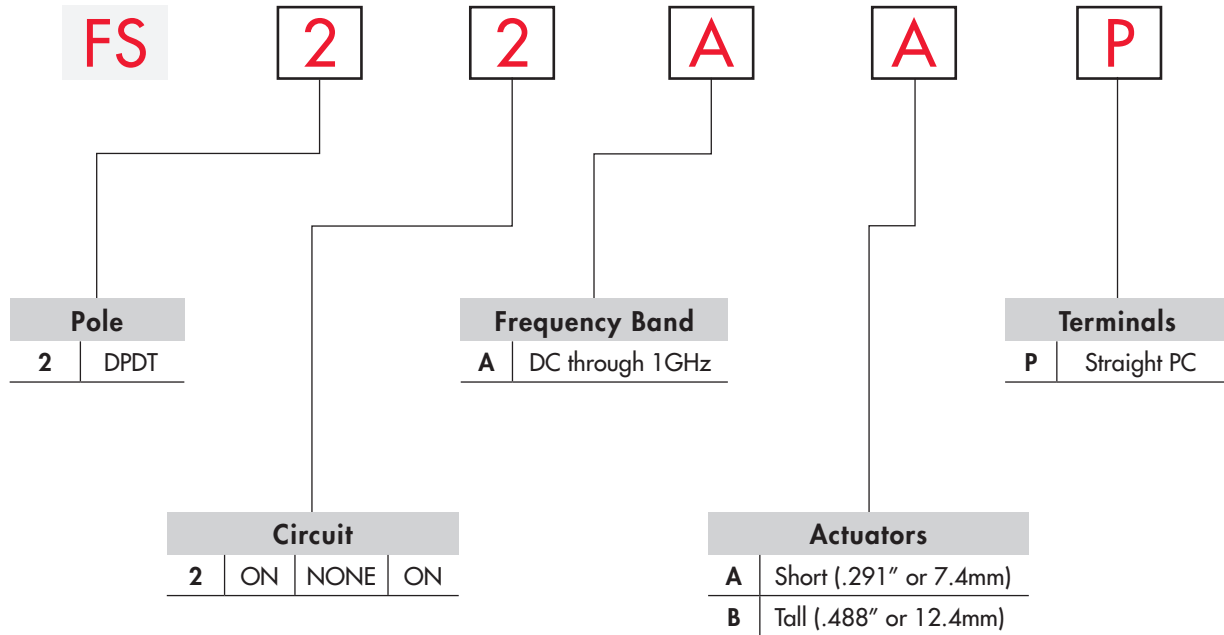

DESCRIPTION FOR TYPICAL ORDERING EXAMPLE

FS22AAP

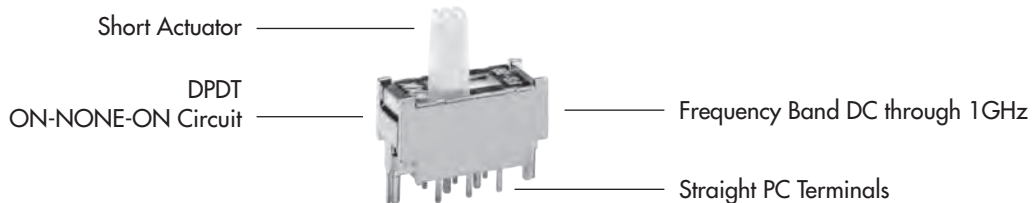

POLE & CIRCUIT

		Slide Position			Connected Terminals			Throw & Schematics
Pole	Model	Left	Center	Right	Left	Center	Right	Note: Terminal numbers are not actually on the switch.
DP	FS22	ON	NONE	ON	2-1 5-4	NA	2-3 5-6	

HIGH FREQUENCY PERFORMANCE

RF Connection Options

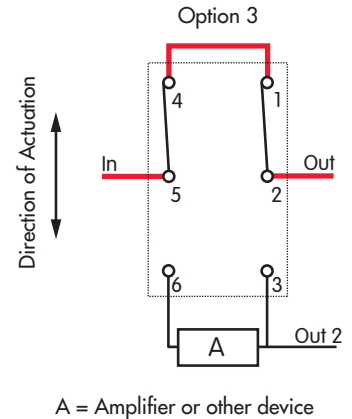
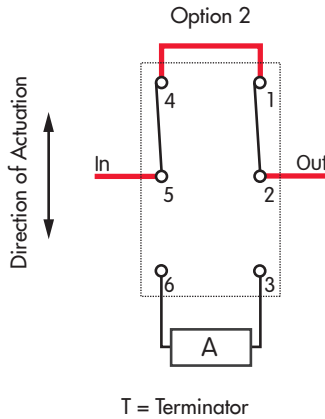
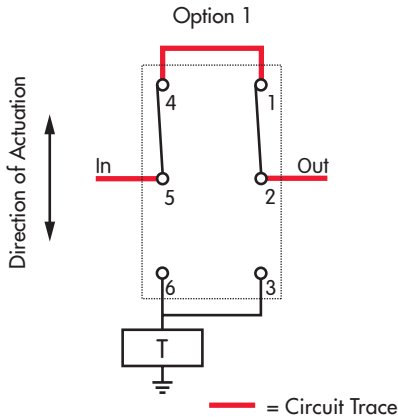

Isolation

>40dB @ 1GHz
(higher value is better)

Insertion Loss

<0.5dB @ 1GHz
(lower value is better)

Standing Wave Ratio or Impedance Matching

Standing Wave = ratio between highest voltage & lowest voltage
(must always be more than 1)

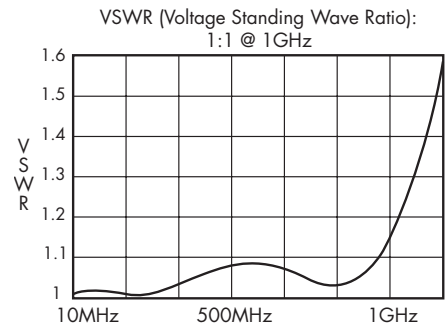
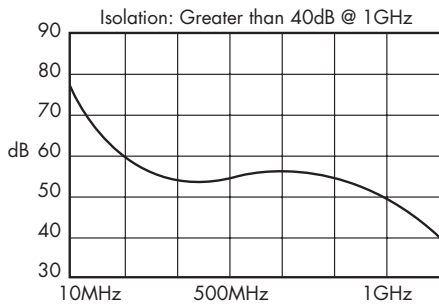

Note: The data above reflects the conditions using the FS switch on a test PCB with two coaxial connectors. High frequency applications require external connection on the PCB. Contact factory for details.

TYPICAL SWITCH DIMENSIONS

Short & Tall Actuators

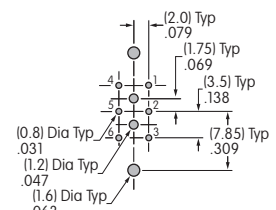
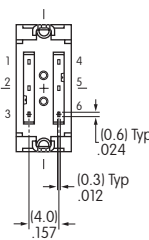
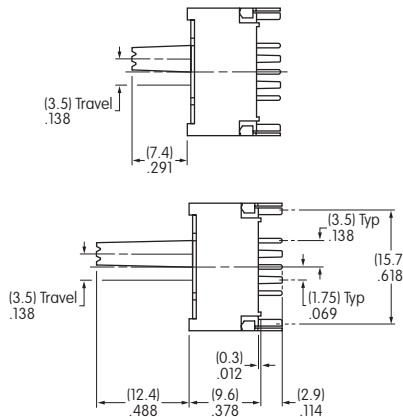
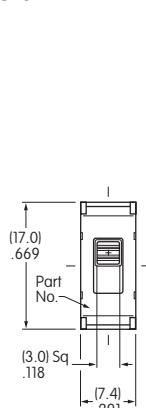

FS22ABP

Actuator in LEFT position.

General Specifications

Electrical Capacity (Resistive Load)

Switching Rating: 25mA @ 24V DC
Nonswitching Rating: 0.1A @ 50V DC

Other Ratings

Contact Resistance: 50 milliohms maximum
Insulation Resistance: 100 megohms minimum @ 500V DC
Dielectric Strength: 500V AC minimum for 1 minute minimum
Mechanical Life: 2,000 operations minimum
Electrical Life: 2,000 operations minimum
Total Travel: For slide actuator: .031" (0.8mm); for piano actuator: .114" (2.9mm)

Materials & Finishes

	JS01 Slide DIP	JS03 Piano DIP
Actuator:	Glass fiber reinforced polyamide	Glass fiber reinforced PBT
Cover:	Glass fiber reinforced polyamide (UL94V-0)	Glass fiber reinforced PBT (UL94V-0)
Base:	Glass fiber reinforced polyamide (UL94V-0)	Glass fiber reinforced PBT (UL94V-0)
Contacts:	Beryllium copper with gold plating	Phosphor bronze with gold plating
Terminals:	Brass with gold plating	Phosphor bronze with gold plating

Environmental Data

Operating Temp Range: -25°C through +70°C (-13°F through +158°F)
Humidity: 90 ~ 95% humidity for 96 hours @ 40°C (104°F)
Vibration: 10 ~ 55Hz with peak-to-peak amplitude of 1.5mm traversing the frequency range & returning in 1 minute; 3 right angled directions for 2 hours
Shock: 50G (490m/s²) acceleration (tested in 6 right angled directions, with 5 shocks in each direction)

PCB Processing

Soldering: Wave Soldering Recommended. See Profile A in Supplement section.
 Manual Soldering: See Profile A in Supplement section.
 Note: Switches are packaged in OFF position and should be soldered in OFF position.
Cleaning: These devices are not process sealed. Hand clean locally using alcohol based solution.

Standards & Certifications

Flammability Standards: UL 94V-0 rated cover & base
 The JS series devices have not been tested for UL recognition and CSA certification. These switches are designed for use in a low-voltage, low-current circuit. When used as intended in a low-voltage, low-current circuit, the results do not produce hazardous energy.

Toggle

Rockers

Pushbuttons

Illuminated PB

Programmable

Keylocks

Rotaries

Slides

Tactiles

Tilt

Touch

Indicators

Accessories

Supplement

Distinctive Characteristics

Slide type and piano type actuators available.

Twin sliding contact mechanism with self-cleaning action (JS01) provides smooth actuation and produces high contact reliability.

Gold plated contacts prevent oxidation and sulfide effect and provide stable contact resistance.

Use of self-extinguishing UL94V-0 certified material in cover and base provides high arc resistance and high insulation resistance.

Slanted terminals ensure secure PCB mounting and prevent dislodging during wave soldering.

Terminal spacing conforms to standard .100" (2.54mm) PCB grid.

End-to-end stackable.

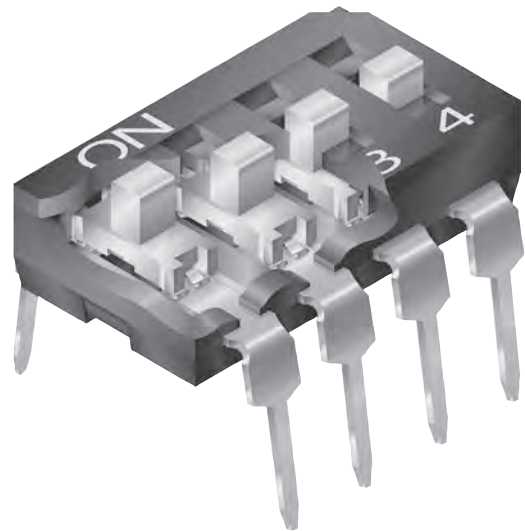

Actual Sizes

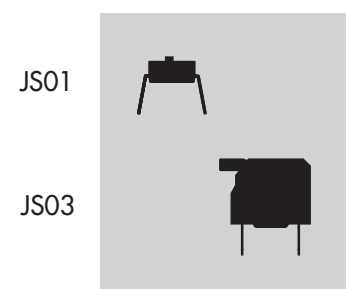

TYPICAL SWITCH ORDERING EXAMPLE

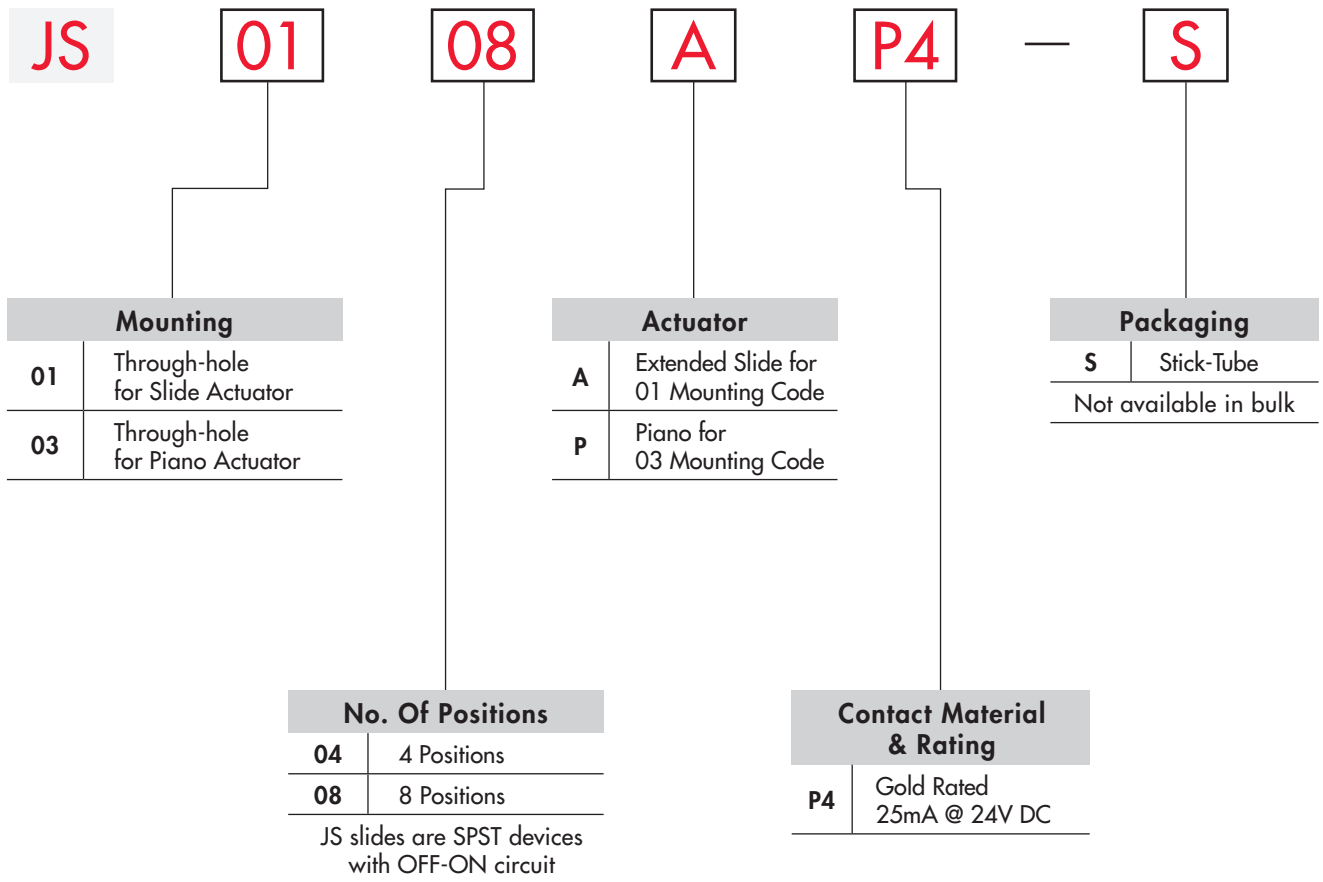

DESCRIPTION FOR TYPICAL ORDERING EXAMPLE

JS0108AP4-S

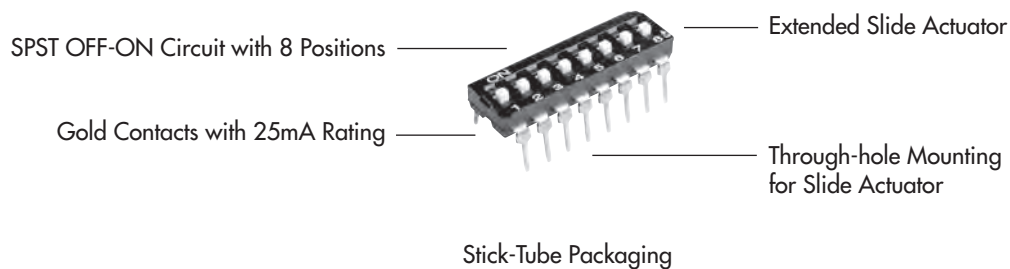

TYPICAL SWITCH DIMENSIONS

Slide Actuator

4 Positions

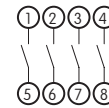
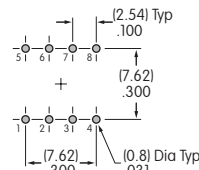
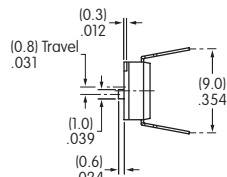
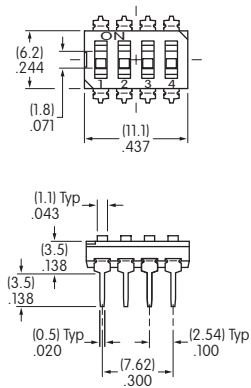

End View

Schematic

JS0104AP4

Slide Actuator

8 Positions

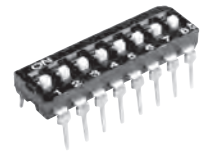
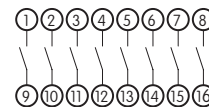
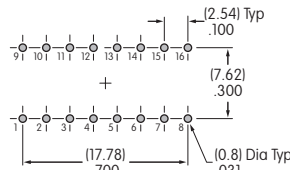
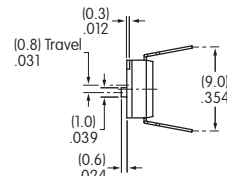
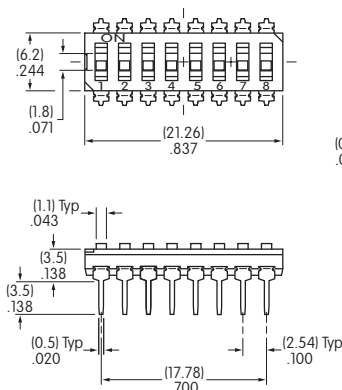

End View

Schematic

JS0108AP4

Piano Actuator

4 Positions

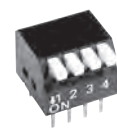
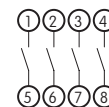
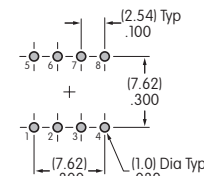
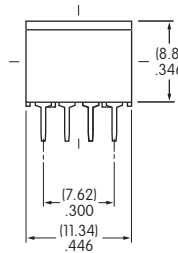
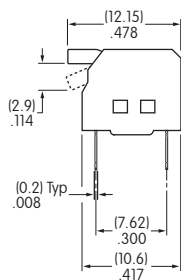
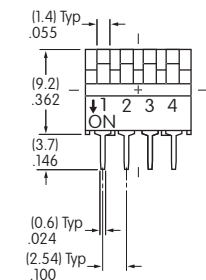

Schematic

JS0304PP4

Piano Actuator

8 Positions

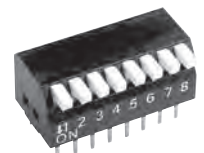
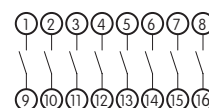
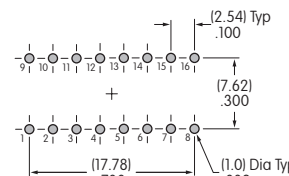
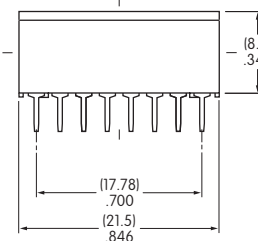
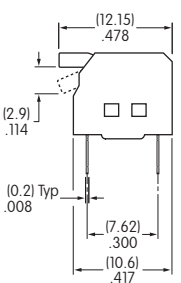
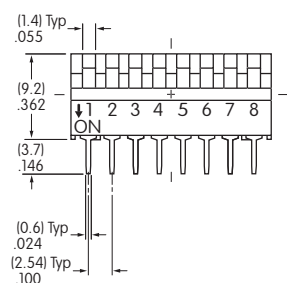

Schematic

JS0308PP4

PACKAGING

S

Stick-Tube Packaging

Switches are not available in bulk and must be ordered in increments of:

Slide Actuator

JS0104AP4-S: 46 pieces per stick-tube

JS0108AP4-S: 24 pieces per stick-tube

Piano Actuator

JS0304PP4-S: 44 pieces per stick-tube

JS0308PP4-S: 23 pieces per stick-tube

Switches are packaged in OFF position.

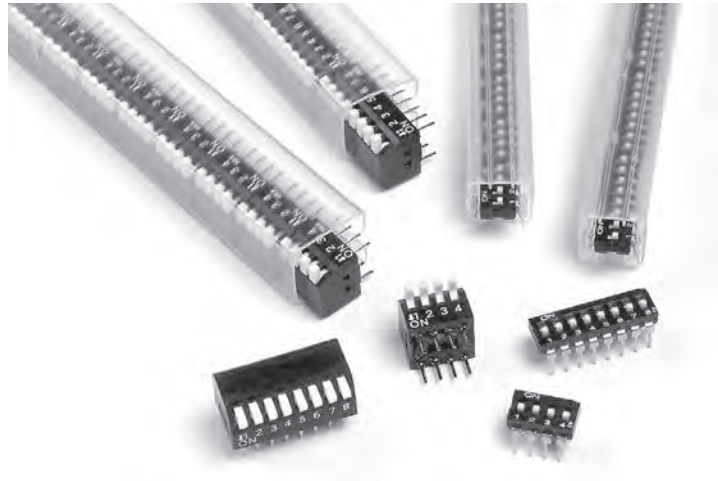

**Stick-Tube Dimensions for Slide Actuator
JS0104AP4-S & JS0108AP4-S**

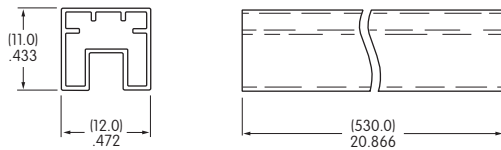

**Stick-Tube Dimensions for Piano Actuator
JS0304PP4-S & JS0308PP4-S**

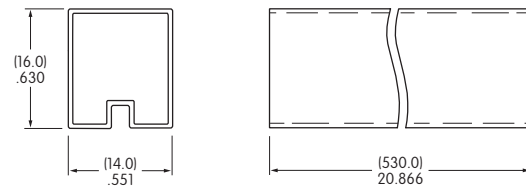

Toggles

Rockers

Pushbuttons

Illuminated PB

Programmable

Keylocks

Rotaries

Slides

Tactiles

Tilt

Touch

Indicators

Accessories

Supplement

General Specifications

Toggles
Rocker
Pushbuttons
Illuminated PB
Programmable
Keylocks
Rotaries
Slides
Tactiles
Tilt
Touch
Indicators
Accessories
Supplement

Electrical Capacity (Resistive Load)

Switching Rating: 25mA @ 24V DC
Nonswitching Rating: 0.1A @ 50V DC

Other Ratings

	JS02 Extended Actuator	JS04 Flush Actuator
Contact Resistance:	50 milliohms maximum	50 milliohms maximum
Insulation Resistance:	100 megohms minimum @ 500V DC	100 megohms minimum @ 100V DC
Dielectric Strength:	500V AC minimum for 1 minute minimum	300V AC minimum for 1 minute minimum
Mechanical Life:	2,000 operations minimum	2,000 operations minimum
Electrical Life:	2,000 operations minimum	2,000 operations minimum
Total Travel:	.031" (0.8mm)	.026" (0.65mm)

Materials & Finishes

	JS02 Extended Actuator	JS04 Flush Actuator
Actuator:	Glass fiber reinforced polyamide	Glass fiber reinforced polyamide
Cover:	Glass fiber reinforced polyamide (UL94V-0)	Glass fiber reinforced polyamide (UL94V-0)
Base:	Glass fiber reinforced polyamide (UL94V-0)	Glass fiber reinforced polyamide (UL94V-0)
Contacts:	Beryllium copper with gold plating	Copper alloy with gold plating
Terminals:	Brass with gold plating	Brass with gold plating

Environmental Data

Operating Temp Range: **JS02 Extended Actuator:** -20°C through +70°C (-4°F through +158°F)
JS04 Flush Actuator: -30°C through +85°C (-22°F through +185°F)

Humidity: 90 ~ 95% humidity for 96 hours @ 40°C (104°F)

Vibration: 10 ~ 55Hz with peak-to-peak amplitude of 1.5mm traversing the frequency range & returning in 1 minute; 3 right angled directions for 2 hours

Shock: 50G (490m/s²) acceleration (tested in 6 right angled directions, with 5 shocks in each direction)

PCB Processing

Soldering: Reflow Soldering Recommended. See Profile A in Supplement section.
Manual Soldering: See Profile A in Supplement section.
Note: Switches are packaged in OFF position and should be soldered in OFF position.

Cleaning: These devices are not process sealed. Hand clean locally using alcohol based solution.

Standards & Certifications

Flammability Standards: UL 94V-0 rated cover & base
The JS Series slides have not been tested for UL recognition or CSA certification. These switches are designed for use in a low-voltage, low-current circuit. When used as intended in a low-voltage, low-current circuit, the results do not produce hazardous energy.

Distinctive Characteristics

Extended and flush slide actuators available.

Twin sliding contact mechanism with self-cleaning action (JS02) provides smooth actuation and produces high contact reliability.

Gold plated contacts prevent oxidation and sulfide effect and provide stable contact resistance.

Use of self-extinguishing UL94V-0 certified material in cover and base provides high arc resistance and high insulation resistance.

Gull-wing terminals ensure secure PCB mounting and prevent dislodging during vapor phase and infrared convection reflow soldering.

Terminal spacing conforms to standard PCB grid.
For JS02: .100" (2.54mm)
For JS04: .050" (1.27mm)

End-to-end stackable.

Packaged in tape-reel or stick-tube. Tape-reel packaging meets EIA-481-D Standard.

Coplanarity: all considered surfaces must lie between two parallel planes that are a maximum distance apart of .0059" (0.15mm). (Additional coplanarity details in Terms and Acronyms in the Supplement section.)

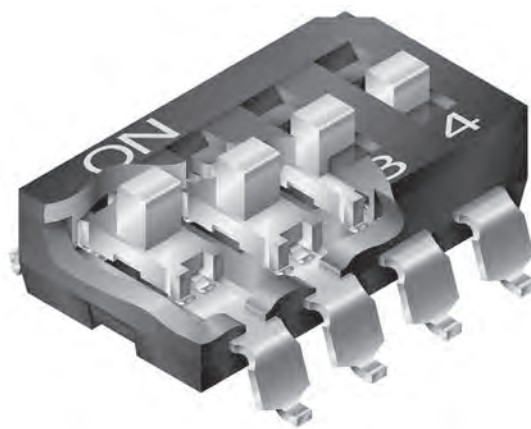

Actual Sizes

JS02



JS04



TYPICAL SWITCH ORDERING EXAMPLE

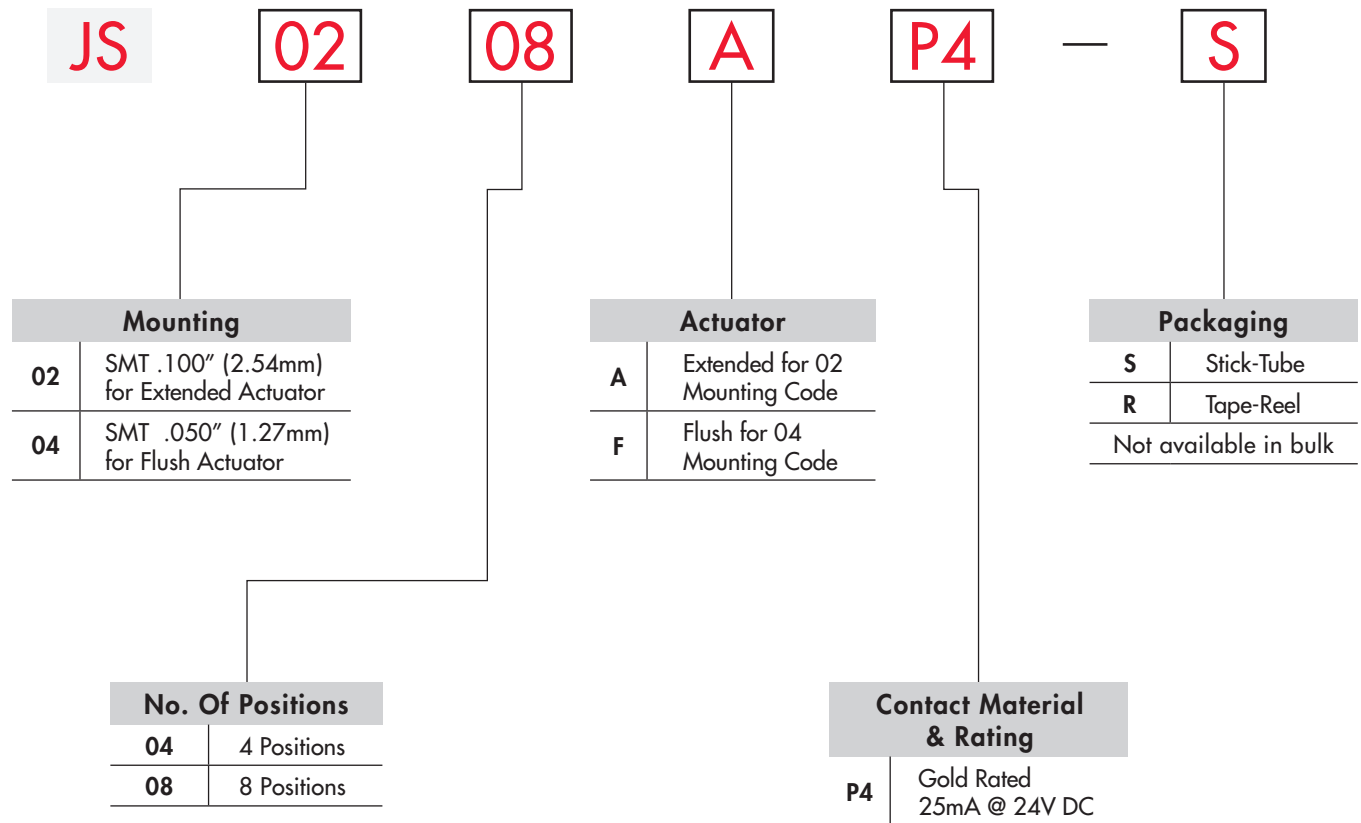

DESCRIPTION FOR TYPICAL ORDERING EXAMPLE

JS0208AP4-S

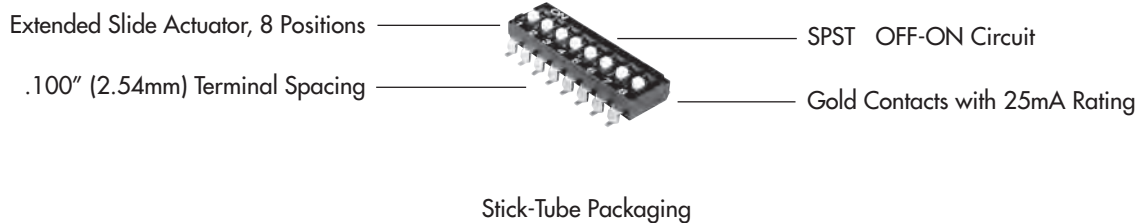

TYPICAL SWITCH DIMENSIONS

Single Pole

4 Positions • Extended Actuator

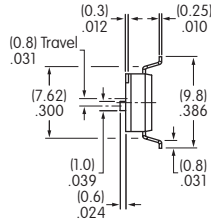
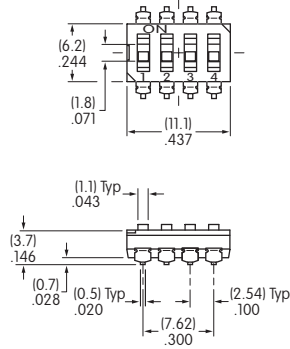

End View

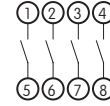
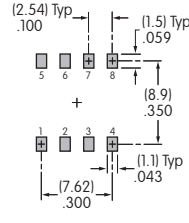

Schematic

JS0204AP4

Single Pole

8 Positions • Extended Actuator

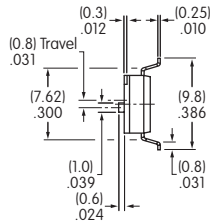
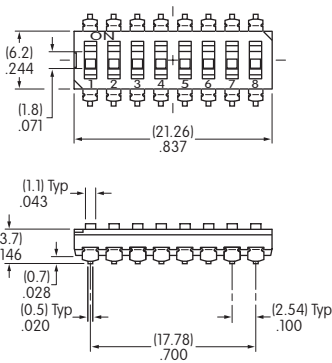

End View

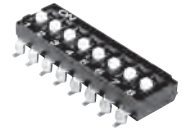
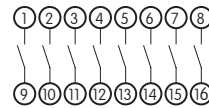
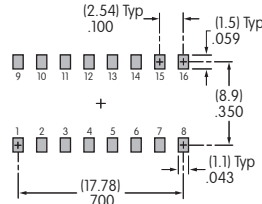

Schematic

JS0208AP4

Single Pole

4 Positions • Flush Actuator

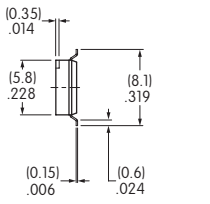
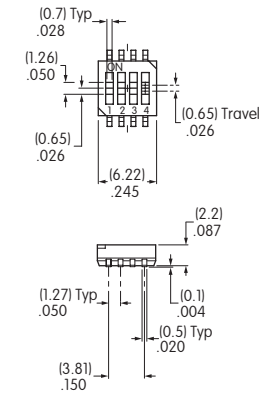

End View

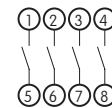
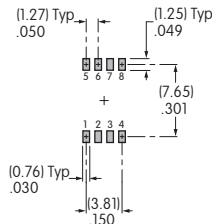

Schematic

JS0404FP4

Single Pole

8 Positions • Flush Actuator

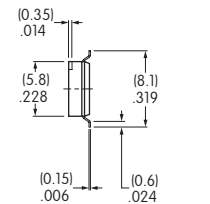
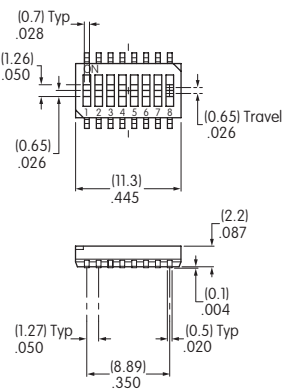

End View

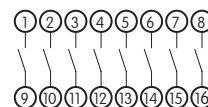
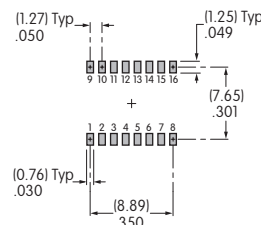

Schematic

JS0408FP4

PACKAGING

S

Stick-Tube Packaging

Switches are packaged in OFF position. Switches are not available in bulk and must be ordered in the following increments:

Extended Actuator

JS0204AP4-S: 46 pieces per stick-tube
 JS0208AP4-S: 24 pieces per stick-tube

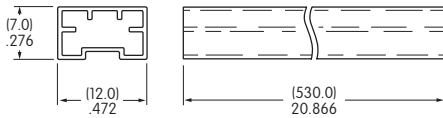

Flush Actuator

JS0404FP4-S: 80 pieces per stick-tube
 JS0408FP4-S: 45 pieces per stick-tube

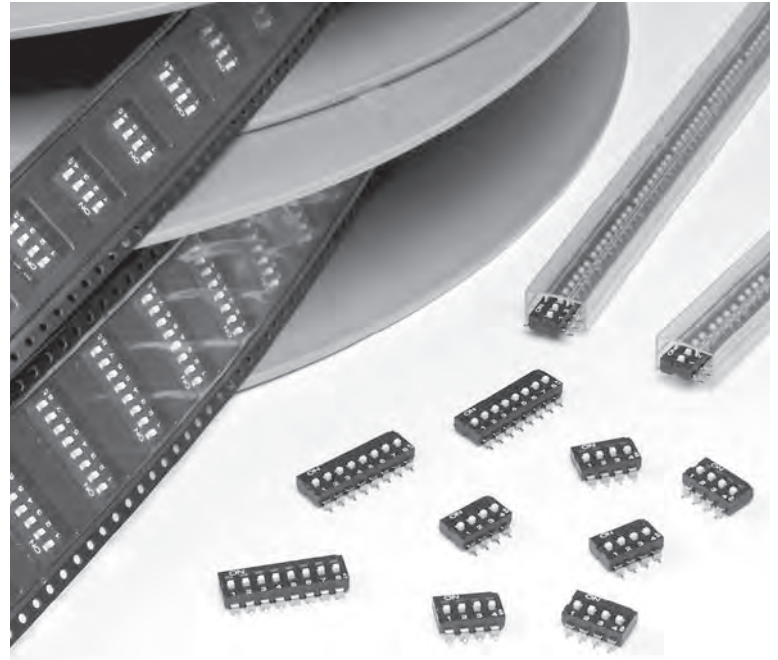
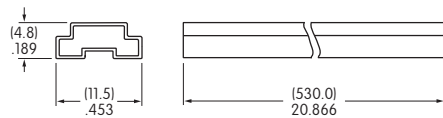

R

Tape-Reel Packaging for Extended Actuator

Switches are packaged in OFF position. Switches are not available in bulk and must be ordered in the following increments:

JS0204AP4-R: 500 pieces per tape-reel
 JS0208AP4-R: 500 pieces per tape-reel

Minimum Leader Length: 15.75" (400mm)
 Minimum Trailer Length: 6.3" (160mm)

Tape-reel packaging meets EIA-481-D Standard.

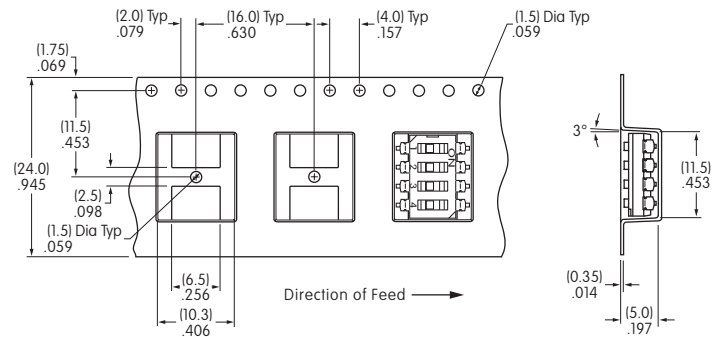

Tape Dimensions for JS0204AP4-R

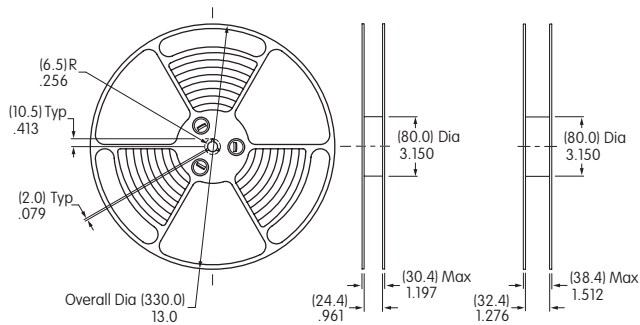

Reel Dimensions JS0204AP4-R JS0208AP4-R

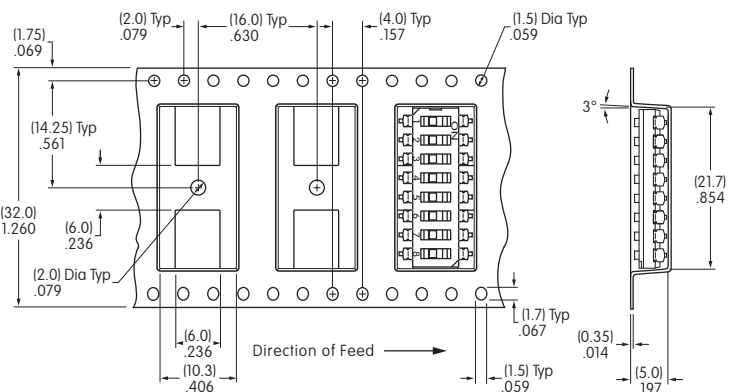

Tape Dimensions for JS0208AP4-R

Toggle

Rockers

Pushbuttons

Illuminated PB

Keylocks

Rotaries

Slides

Tactiles

Tilt

Touch

Indicators

Accessories

Supplement

PACKAGING (CONTINUED)

R

Tape-Reel Packaging for Flush Actuator

Switches are packaged in OFF position.
Switches are not available in bulk and must be ordered in the following increments:

JS0404FP4-R: 2,000 pieces per tape-reel
JS0408FP4-R: 2,000 pieces per tape-reel

Minimum Leader Length: 15.75" (400mm)
Minimum Trailer Length: 6.3" (160mm)

Tape-reel packaging meets EIA-481-D Standard.

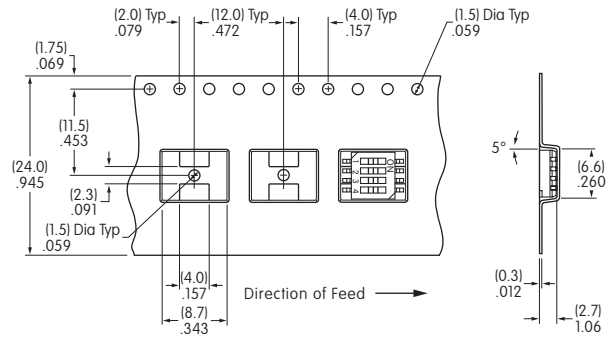

Tape Dimensions for JS0404FP4-R

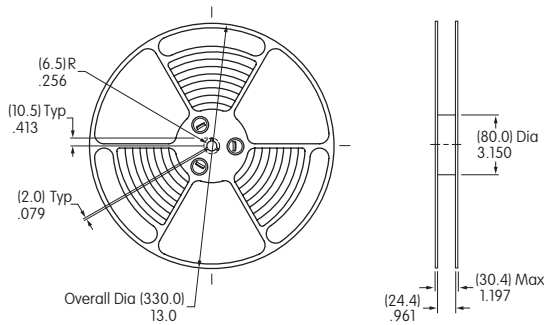

Reel Dimensions for JS0404FP4-R & JS0408FP4-R

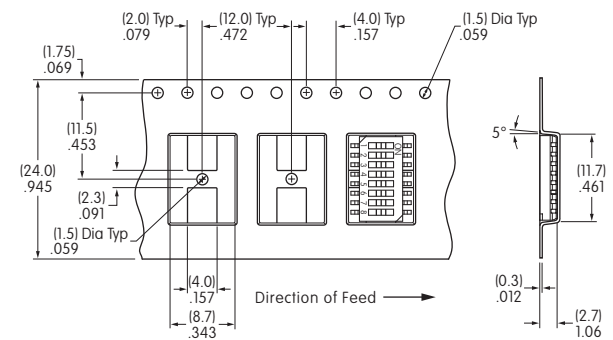

Tape Dimensions for JS0408FP4-R

Toggle

Rockers

Pushbuttons

Illuminated PB

Programmable

Key locks

Rotaries

H Slides

Tactiles

Tilt

Touch

Indicators

Accessories

Supplement

General Specifications

Electrical Capacity (Resistive Load)

Power Level (silver):	6A @ 125V AC or 3A @ 250V AC
Logic Level (gold):	0.4VA maximum @ 28V AC/DC maximum (Applicable Range 0.1mA ~ 0.1A @ 20mV ~ 28V)
Logic/Power Level: (gold over silver)	Combines silver & gold ratings

Note: Find additional explanation of dual rating & operating range in Supplement section.

Other Ratings

Contact Resistance:	10 milliohms maximum for silver; 20 milliohms maximum for gold
Insulation Resistance:	1,000 megohms minimum @ 500V DC
Dielectric Strength:	1,000V AC minimum between contacts for 1 minute minimum; 1,500V AC minimum between contacts & case for 1 minute minimum
Mechanical Life:	100,000 operations minimum
Electrical Life:	25,000 operations minimum for silver; 50,000 operations minimum for gold
Contact Timing:	Nonshorting (break-before-make)
Total Travel:	On-None-On circuit .087" (2.2mm); all other circuits .138" (3.5mm)

Materials & Finishes

Actuator:	Glass fiber reinforced PBT resin (UL94V-0)
Frame:	Stainless steel for panel & PCB mount; phosphor bronze with tin plating for bracket mount
Dust Cover:	Phosphor bronze with nickel plating
Case:	Glass fiber reinforced diallyl phthalate resin (UL94V-0)
Movable Contacts:	Silver alloy (code W); copper with gold plating (code G); or silver alloy with gold plating (code A)
Stationary Contacts:	Silver capped copper with silver plating (code W); copper with gold plating (code G); or silver alloy with gold plating (code A)
Terminals:	Copper or brass with silver or gold plating

Environmental Data

Operating Temp Range:	-30°C through +85°C (-22°F through +185°F)
Humidity:	90 ~ 95% humidity for 96 hours @ 40°C (104°F)
Vibration:	10 ~ 55Hz with peak-to-peak amplitude of 1.5mm traversing the frequency range & returning in 1 minute; 3 right angled directions for 2 hours
Shock:	50G (490m/s ²) acceleration (tested in 6 right angled directions, with 5 shocks in each direction)

Processing

Soldering:	Wave Soldering recommended (PC Mount). See Profile A in Supplement section. Manual Soldering: See Profile A in Supplement section.
Cleaning:	These devices are not process sealed. Hand clean locally using alcohol based solution.

Standards & Certifications

Flammability Standards:	UL94V-0 rated actuator & case
UL:	File No. E44145 - Recognized only when ordered with marking on switch. Add "/U" or "/CUL" to end of part number to order UL recognized switch. All Single & Double Pole Double Throw models recognized at 6A @ 125V AC & 3A @ 250V AC.
CSA:	File No. 023535_0_000 - Certified only when ordered with marking on switch. Add "/C" to end of part number to order CSA certified switch. All Double Throw & 3 Throw models certified at 6A @ 125V AC, 3A @ 250V AC, & 0.4VA maximum @ 28V DC.

Distinctive Characteristics

Available in flat frame and bracketed PC mounting types.

Over-center actuator block and plunger design gives crisp actuation with clear indication of circuit status; this design also diminishes sparking and increases operating life.

Guide interlocked with actuator block prevents window locking and maintains correct plunger alignment to assure contact stability.

Antijamming design protects contacts from damage due to excessive downward force on the actuator.

High internal barriers between poles and insulating sheet between case and actuator block give added protection to contacts.

Specially composed silver alloy contacts for power applications or gold contacts for logic level applications give high contact reliability.

Prominent external insulating barriers increase insulation resistance and dielectric strength.

Epoxy sealed terminals prevent entry of flux, solvents, and other contaminants.

Clinching of frame to case well above base and terminals provides 1,500V dielectric strength.

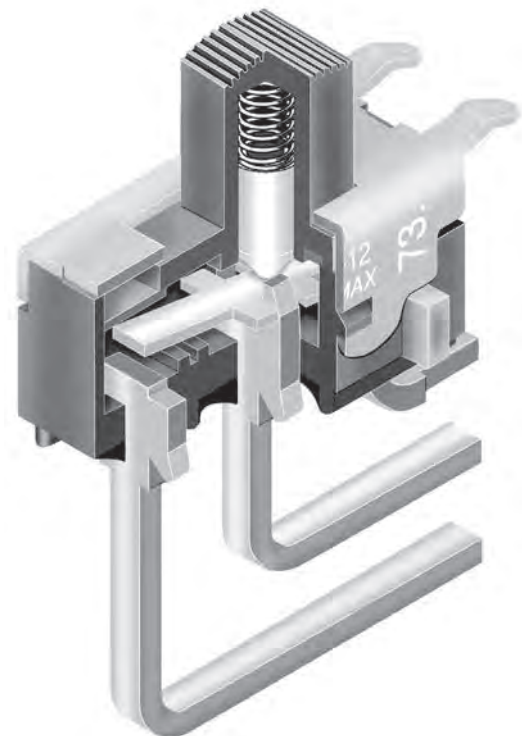

Actual Size

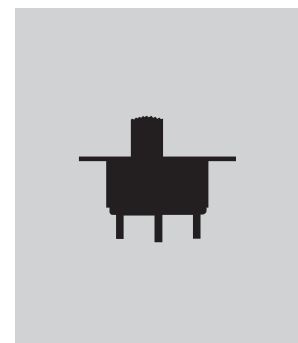

Toggle

Rockers

Pushbuttons

Illuminated PB

Programmable

Key locks

Rotaries

H Slides

Tactiles

Tilt

Touch

Indicators

Accessories

Supplement

TYPICAL SWITCH ORDERING EXAMPLE

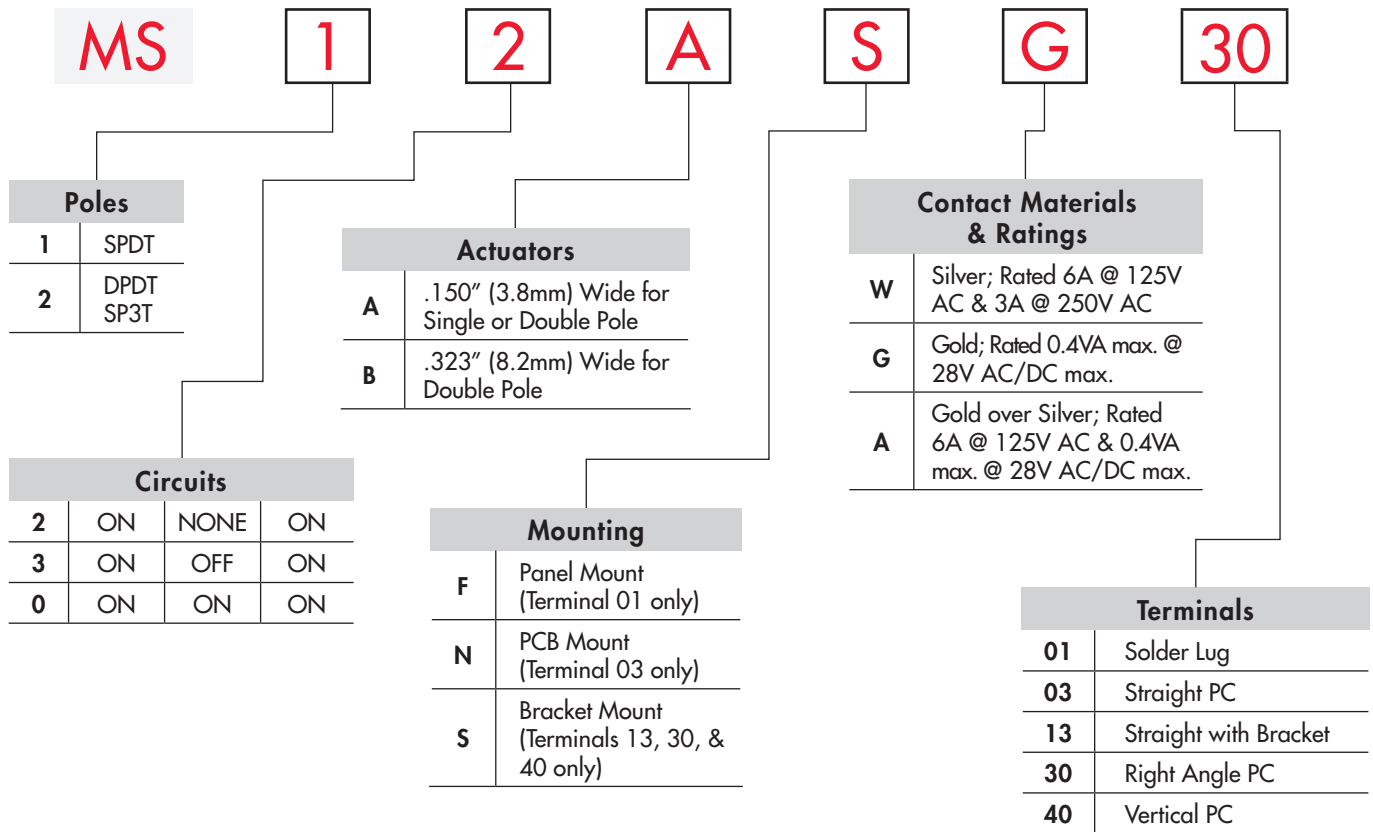

IMPORTANT:



Switches are supplied without UL, cULus & CSA marking unless specified. **UL, cULus & CSA recognized only when ordered with marking on the switch.** Specific models, ratings, & ordering instructions are noted on the General Specifications page.

DESCRIPTION FOR TYPICAL ORDERING EXAMPLE

MS12ASG30



POLES & CIRCUITS

Pole	Model	Slide Position			Connected Terminals			Throw & Schematics
		Left	Center	Right	Left	Center	Right	
								Note: Terminal numbers are not actually on the switch.
SP	MS12 MS13	ON ON	NONE OFF	ON ON	2-1	OPEN	2-3	SPDT
DP	MS22 MS23	ON ON	NONE OFF	ON ON	2-1 5-4	OPEN	2-3 5-6	DPDT

For 3 Throw (3-On)

Pole	Model	Connected Terminals & Schematics			External Connection
		Left	Center	Right	
SP	MS20	ON 2-1 5-4	ON 2-3 5-4	ON 2-3 5-6	The SP3T model utilizes a double pole base. External connections must be made during field installation.

ACTUATORS

A .150" (3.8mm) Wide for Single Pole

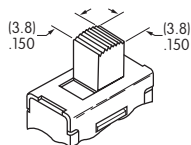

.150" (3.8mm) Wide for Double Pole

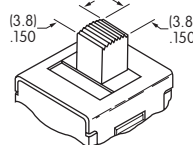

B .323" (8.2mm) Wide for Double Pole Only

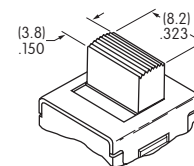

CONTACT MATERIALS & RATINGS

W Silver over Silver Power Level 6A @ 125V AC & 3A @ 250V AC

G Gold over Brass or Copper Logic Level 0.4VA maximum @ 28V AC/DC maximum
Note: Complete explanation of operating range in Supplement section.

A Gold over Silver Power Level or Logic Level 6A @ 125V AC or 0.4VA maximum @ 28V AC/DC maximum

Note: This dual rated option is suitable when two or more identical switches are used in logic and in power circuits within the same application. See Supplement section for complete explanation of dual rating and operating range.

MOUNTING TYPES & TERMINALS

F Panel Mount
(Combines with Solder Lug Terminal 01 only)

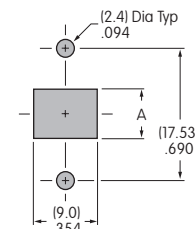
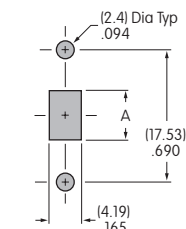

N Straight PC Mount
(Combines with Straight PC Terminal 03 only)



Dimension A =
.268" (6.8mm) for on-none-on
.319" (8.1mm) for on-off-on & on-on-on

SP or DP with .150"
(3.8mm) Actuator

DP only with .323"
(8.2mm) Actuator

Maximum Panel Thickness: .197" (5.0mm)

S Support Bracket Mount
(For Terminals 13, 30, & 40)



Maximum Panel Thickness:
For Straight PC with Bracket Terminal 13: .197" (5.0mm)
For Angle Mount Terminals 30 & 40: .177" (4.5mm)

01 Solder Lug

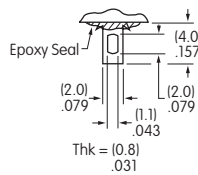

03 Straight PC

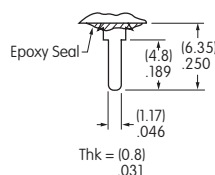

13 Straight PC with Bracket

30 Right Angle PC

40 Vertical PC

TYPICAL SWITCH DIMENSIONS

Solder Lug Terminals

Single Pole

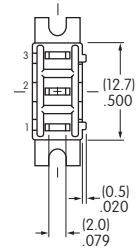
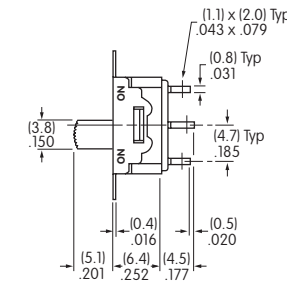
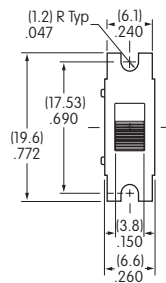

MS12AFW01

Actuator in LEFT Position

Solder Lug Terminals

Double Pole

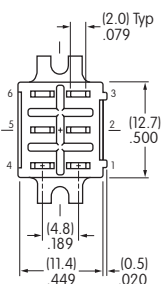
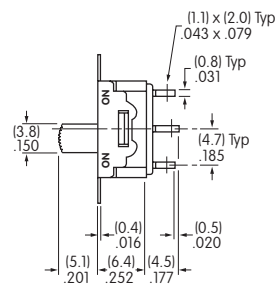
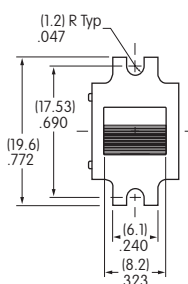
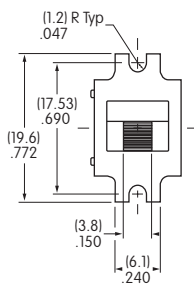

MS22BFW01

Actuator in LEFT Position

Toggles
Rockers
Pushbuttons
Illuminated PB
Programmable
Keylocks
Rotaries
Slides
Tactiles
Tilt
Touch
Indicators
Accessories
Supplement

TYPICAL SWITCH DIMENSIONS

Single Pole

Straight PC Terminals

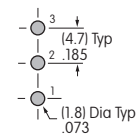
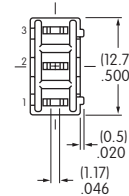
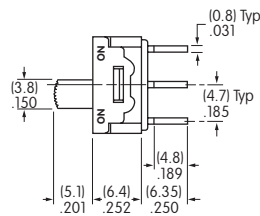
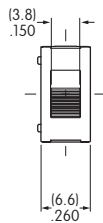

Actuator in LEFT Position

MS12ANG03

Double Pole

Straight PC Terminals

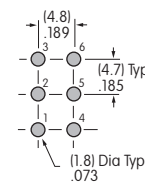
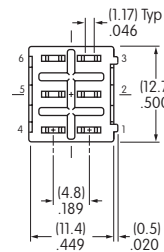
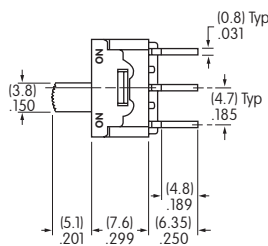
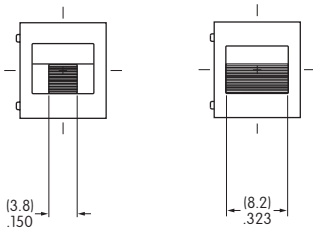

Actuator in LEFT Position

MS22BNG03

Single Pole

Straight PC Terminals with Bracket

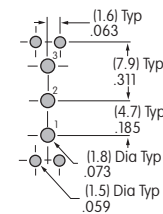
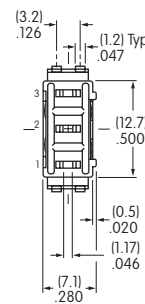
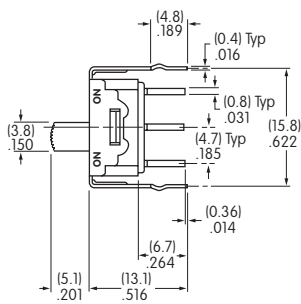
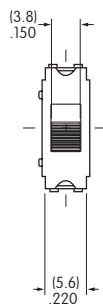

Actuator in LEFT Position

MS12ASG13

Double Pole

Straight PC Terminals with Bracket

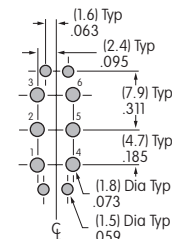
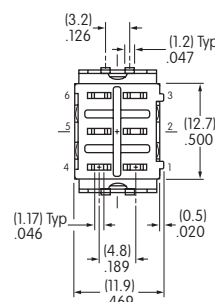
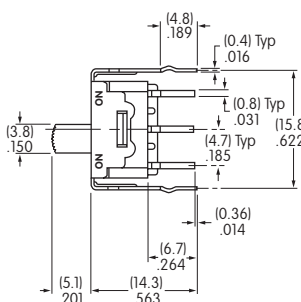
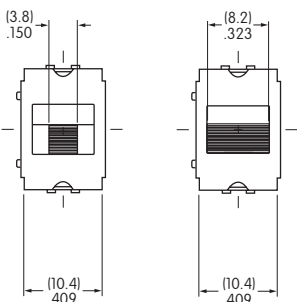

Actuator in LEFT Position

MS22BSG13

TYPICAL SWITCH DIMENSIONS

Right Angle PC Terminals

Single Pole

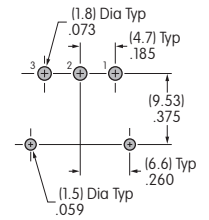
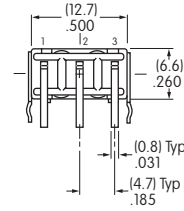
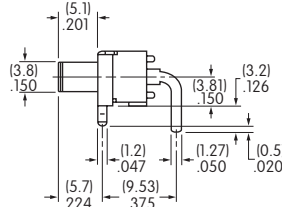
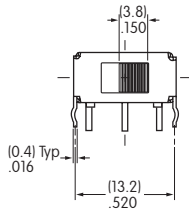

MS12ASG30

Actuator in LEFT Position

Right Angle PC Terminals

Double Pole

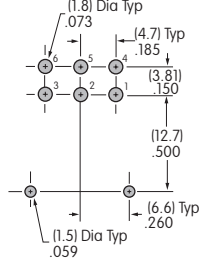
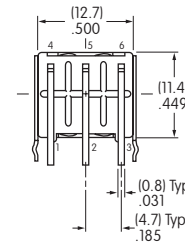
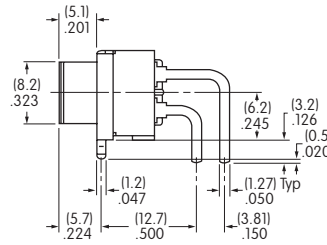
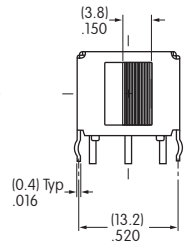
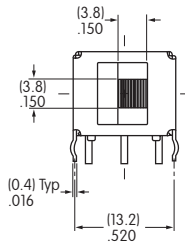

MS22BSG30

Actuator in LEFT Position

Vertical PC Terminals

Single Pole

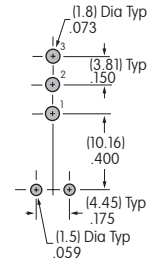
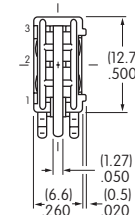
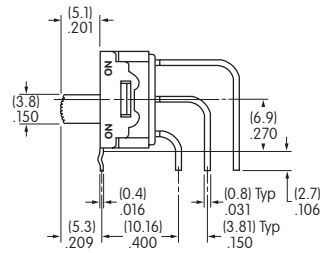
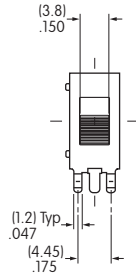

MS12ASG40

Actuator in LEFT Position

Vertical PC Terminals

Double Pole

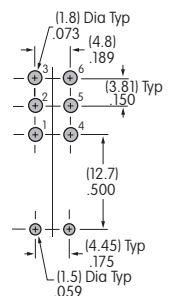
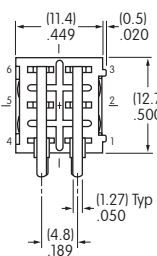
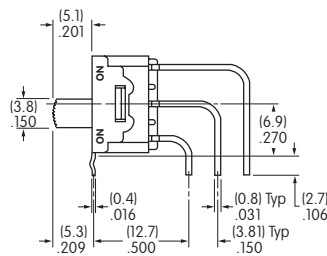
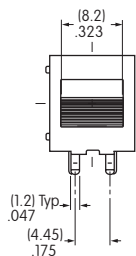
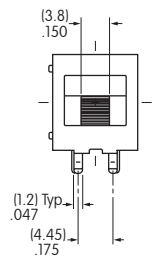

MS22BSG40

Actuator in LEFT Position

General Specifications

Electrical Capacity (Resistive Load)

Power Level: 6A @ 125V AC or 3A @ 250V AC

Other Ratings

Contact Resistance: 10 milliohms maximum

Insulation Resistance: 1,000 megohms minimum @ 500V DC

Dielectric Strength: 1,000V AC minimum between contacts for 1 minute minimum;
1,500V AC minimum between contacts & case for 1 minute minimum

Mechanical Life: 50,000 operations minimum

Electrical Life: 25,000 operations minimum

Contact Timing: Nonshorting (break-before-make)

Total Travel: .087" (2.2mm)

Materials & Finishes

Actuator: Polyamide (UL94V-0)

Frame: Stainless steel

Case: Glass fiber reinforced diallyl phthalate resin (UL94V-0)

Movable Contacts: Silver alloy

Stationary Contacts: Silver capped copper with silver plating

Terminals: Copper or brass with silver plating

Environmental Data

Operating Temp Range: -10°C through +55°C (+14°F through +131°F)

Humidity: 90 ~ 95% humidity for 96 hours @ 40°C (104°F)

Vibration: 10 ~ 55Hz with peak-to-peak amplitude of 1.5mm traversing the frequency range
& returning in 1 minute; 3 right angled directions for 2 hours

Shock: 50G (490m/s²) acceleration (tested in 6 right angled directions, with 5 shocks in each direction)

Processing

Soldering Time & Temp: Wave Soldering Recommended (PC version): See Profile A in Supplement section.

Manual Soldering: See Profile A in Supplement section.

Note: Lever must be in center position while soldering.

Cleaning: These devices are not process sealed. Hand clean locally using alcohol based solution.

Standards & Certifications

Flammability Standards: UL94V-0 rated actuator & case

Distinctive Characteristics

Bright, LED illumination at top of actuator.

Over-center actuator block and plunger design gives crisp actuation, diminishes sparking, and increases operating life.

Guide interlocked with actuator block prevents window locking and maintains correct plunger alignment to assure contact stability.

Antijamming design protects contacts from damage due to excessive downward force on the actuator.

High internal barriers between poles and insulating sheet between case and actuator block give added protection to contacts.

Prominent external insulating barriers increase insulation resistance and dielectric strength.

Epoxy sealed terminals prevent entry of flux, solvents, and other contaminants.

Clinching of frame to case well above base and terminals provides 1,500V dielectric strength.

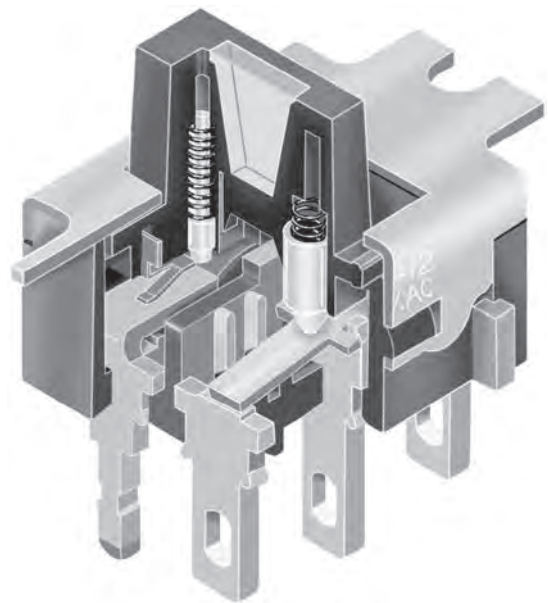

Actual Size

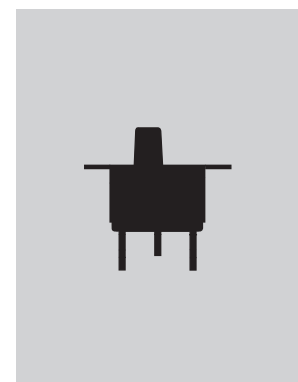

Toggle

Rockers

Pushbuttons

Illuminated PB

Programmable

Key locks

Rotaries

H Slides

Tactiles

Tilt

Touch

Indicators

Accessories

Supplement

TYPICAL SWITCH ORDERING EXAMPLE

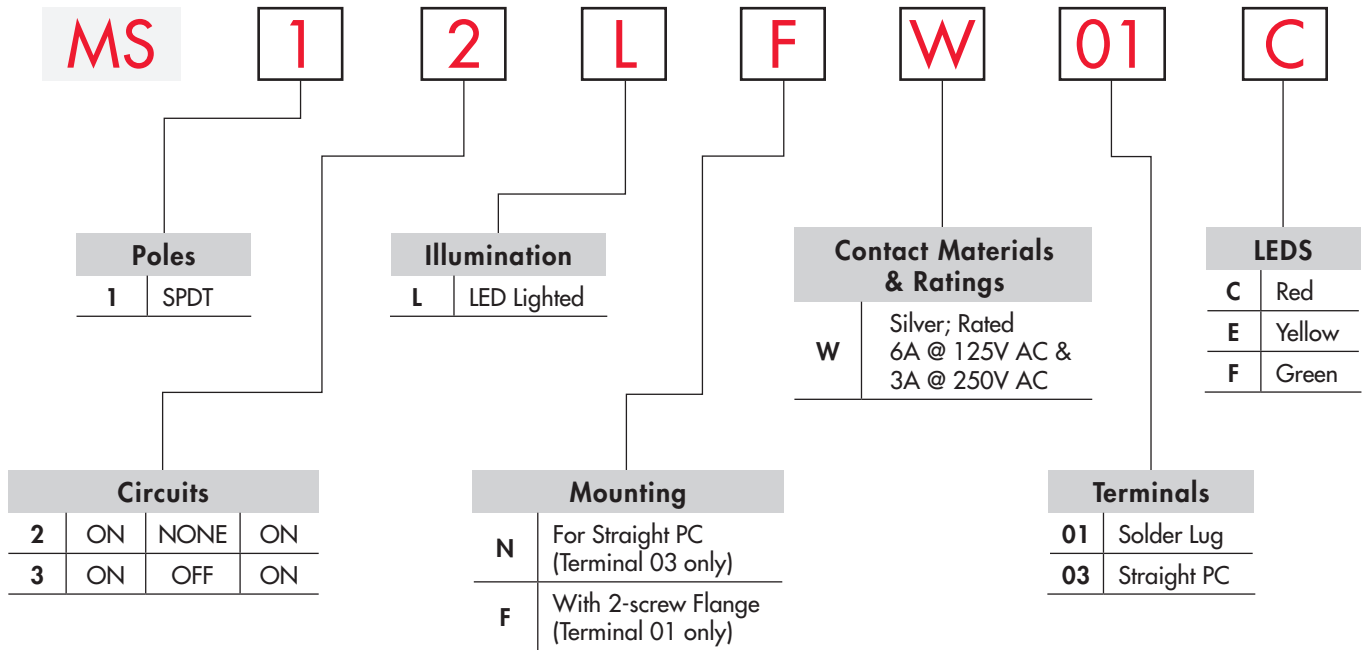

DESCRIPTION FOR TYPICAL ORDERING EXAMPLE

MS12LFW01C

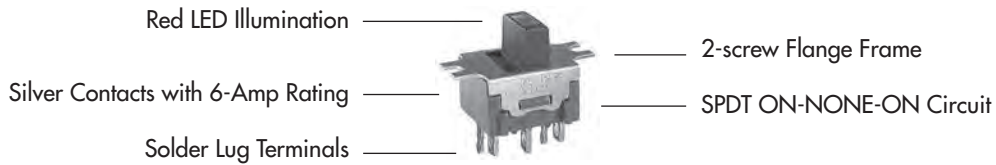

POLES & CIRCUITS

Pole	Model	Slide Position			Connected Terminals			Throw & Schematics
		Left	Center	Right	Left	Center	Right	
SP	MS12	ON	NONE	ON	2-1	OPEN	2-3	Note: Terminal numbers are not actually on the switch. LED circuit is isolated and requires an external connection.
	MS13	ON	OFF	ON				

CONTACT MATERIALS & RATINGS

W	Silver over Silver	Power Level	6A @ 125V AC & 3A @ 250V AC
----------	--------------------	-------------	-----------------------------

MOUNTING TYPES & TERMINALS

N Straight PC Mount
(Combines with
Straight PC Terminal
03 only)



03 Straight PC

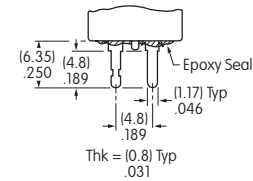

F 2-screw Flange
(Combines with Solder
Lug Terminal 01 only)



01 Solder Lug

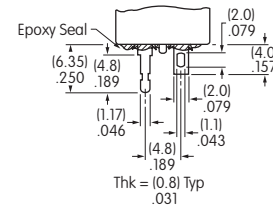

LED COLORS & SPECIFICATIONS

LEDs are supplied as an integral part of the switch (not available separately). The lamp circuit is independent of switch operation. Electrical specifications shown are determined at a basic temperature of 25°C. If the source voltage exceeds the rated voltage, a ballast resistor is required. The resistor value can be calculated by using the formula given in the Supplement.

		C Red	E Yellow	F Green
Maximum Forward Current	I_{FM}	30mA	30mA	25mA
Typical Forward Current	I_F	16mA	16mA	16mA
Forward Voltage	V_F	1.98V	2.06V	2.16V
Maximum Reverse Voltage	V_{RM}	5V	5V	5V
Current Reduction Rate Above 25°C	ΔI_F	0.40mA/°C	0.42mA/°C	0.33mA/°C
Ambient Temperature Range		-15° ~ +60°C		

TYPICAL SWITCH DIMENSIONS

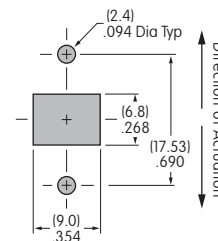
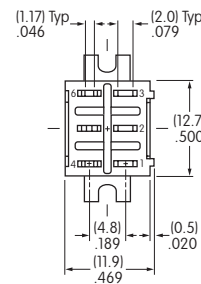
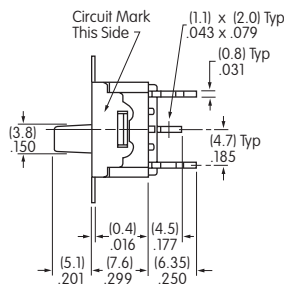
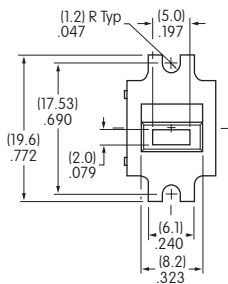

Actuator in LEFT Position

Maximum Panel Thickness .197" (5.0mm)

MS12LFW01C

Straight PC Terminals

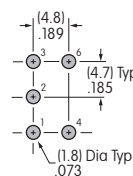
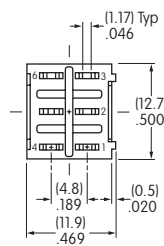
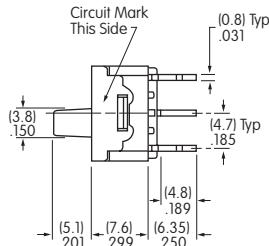
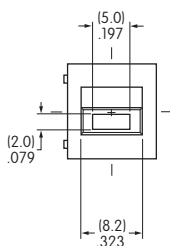

Actuator in LEFT Position

Maximum Panel Thickness .197" (5.0mm)

MS12LNW03C

General Specifications

Electrical Capacity (Resistive Load)

Maximum Level:	500mA @ 12V DC
Minimum Level:	1.0mA maximum @ 10mV AC/DC maximum

Other Ratings

Contact Resistance:	30 milliohms maximum
Insulation Resistance:	100 megohms minimum @ 500V DC
Dielectric Strength:	500V AC for 1 minute minimum
Mechanical Life:	1,000 operations minimum
Electrical Life:	1,000 operations minimum
Nominal Operating Force:	2.0N
Contact Timing:	Nonshorting (Break-before-make)
Total Travel:	.063" (1.6mm)

Materials & Finishes

Actuator:	Glass fiber reinforced polyester (UL94V-0)
Case:	Glass fiber reinforced polyamide (UL94V-0)
Lower Case:	Glass fiber reinforced polyester (UL94V-0)
Movable Contacts:	Brass with gold plating over nickel
Stationary Contacts:	Brass with gold plating over nickel
Terminals:	Brass with gold plating over nickel

Environmental Data

Operating Temp Range:	-40°C through +85°C (-40°F through +185°F)
Humidity:	90-95% humidity for 96 hours @ 40°C (104°F)
Vibration:	10 ~ 55Hz with peak-to-peak amplitude of 1.5mm traversing the frequency range & returning in 1 minute; 3 right angled directions for 2 hours
Shock:	50G (490m/s ²) acceleration (tested in 6 right angled directions, with 5 shocks in each direction)

PCB Processing

Soldering:	Wave Soldering Recommended: See Profile A in Supplement section. Manual Soldering: See Profile B in Supplement section.
Cleaning:	These devices are not process sealed. Hand clean locally using alcohol based solution.

Standards & Certifications

Flammability Standards:	Actuator and lower case of glass fiber reinforced polyester and case of glass fiber reinforced polyamide UL94V-0 The SM series devices have not been tested for UL recognition and CSA certification. These switches are designed for use in a low-voltage, low-current circuit. When used as intended in a low-voltage, low-current circuit, the results do not produce hazardous energy.
--------------------------------	-----------------------------------------------------------------------------------------------------------------------------------------------------------------------------------------------------------------------------------------------------------------------------------------------------------------------------------------------------------------------------------------------

Distinctive Characteristics

Very compact dimensions allow for high density, side-by-side or end-to-end mounting within tight dimensional applications.

Detent mechanism provides positive actuation to indicate circuit status.

Visible indication of position by spot on top of red actuator and through window on side.

Twin sliding contact mechanism with self-cleaning action provides smooth actuation and produces high contact reliability.

.100" x .100" (2.54mm x 2.54mm) center-to-center inch terminal spacing allows standard PC board mounting in side-by-side or end-to-end arrangements.

Insert molded terminals lock out flux, solvents, and other contaminants.

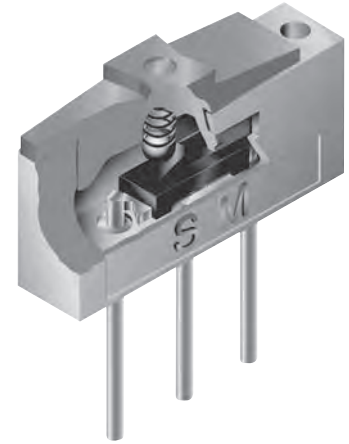

Actual Size

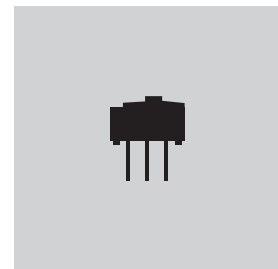

POLES & CIRCUITS

Model	Slide Position			Connected Terminals			Throw & Schematics
	Right	Center	Left	Right	Center	Left	
							Note: Terminal numbers are on the switch.
SM0320102	ON	NONE	ON	1-3	OPEN	1-2	SPDT

TYPICAL SWITCH DIMENSIONS

Single Pole • Straight PC

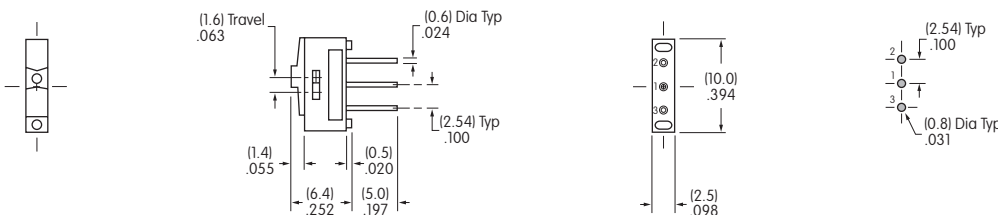

Actuator shown in RIGHT position



SM0320102

- Toggle
- Rockers
- Pushbuttons
- Illuminated PB
- Programmable
- Key locks
- Rotaries
- H Slides**
- Tactiles
- Tilt
- Touch
- Indicators
- Accessories
- Supplement

General Specifications

Electrical Capacity (Resistive Load)

Power Level (silver):	0.1A @ 30V DC
Logic Level (gold):	0.4VA maximum @ 28V AC/DC maximum (Applicable Range 0.1mA ~ 0.1A @ 20mV ~ 28V)
	Note: Find additional explanation of operating range in Supplement section.

Other Ratings

Contact Resistance:	20 milliohms maximum for power level; 40 milliohms maximum for logic level
Insulation Resistance:	100 megohms minimum @ 500V DC
Dielectric Strength:	500V AC minimum 1 minute minimum
Mechanical Life:	10,000 operations minimum
Electrical Life:	10,000 operations minimum
Contact Timing:	SS12S & SS22S – Shorting (make-before-break)
Total Travel:	.079" (2.0mm)

Materials & Finishes

Actuator:	Polyamide
Upper Case:	Polyester for 3-On models; polyacetal for all other models
Lower Case:	Glass fiber reinforced polyester for 3-On models; glass fiber reinforced polybutylene terephthalate (thermoplastic) for other models
Movable Contactor:	Phosphor bronze with silver plating (code 2) or phosphor bronze with gold plating (code 4)
Interior Base:	Phenolic resin (thermoset)
Terminals:	Brass with silver plating over copper plating or brass with gold plating

Environmental Data

Operating Temp Range:	-15°C through +60°C (+5°F through +140°F)
Humidity:	90 ~ 95% humidity for 96 hours @ 40°C (104°F)
Vibration:	10 ~ 55Hz with peak-to-peak amplitude of 1.5mm traversing the frequency range & returning in 1 minute; 3 right angled directions for 2 hours
Shock:	50G (490m/s ²) acceleration (tested in 6 right angled directions, with 5 shocks in each direction)

PCB Processing

Soldering:	Wave Soldering: For non-supported through-hole, see Profile B in Supplement section. For supported through-hole, 5 seconds maximum @ 250°C maximum. Manual Solder: See Profile B in Supplement section.
Cleaning:	These devices are not process sealed. Hand clean locally using alcohol based solution.

Standards & Certifications

The SS series devices have not been tested for UL recognition and CSA certification. These switches are designed for use in a low-voltage, low-current circuit. When used as intended in a low-voltage, low-current circuit, the results do not produce hazardous energy.

Distinctive Characteristics

Top or side actuation permits flexible board design.

Compact dimensions and low profile allow high density mounting and close stacking of PC boards.

Crisp actuation positively indicates circuit status.

Double molded thermoset base and thermo-plastic housing prevent loosening of terminals due to high soldering temperatures.

Award-winning STC mechanism with benefits unavailable in conventional mechanisms: smoother, positive detend actuation, increased contact stability, and unparalleled logic-level reliability. (Additional STC details in Terms and Acronyms in the Supplement section.)

Insert molded terminals lock out flux, solvents, and other contaminants.

Inch or metric terminal spacing for standard PC board grid (.100" x .100" or 2.0mm x 2.0mm).

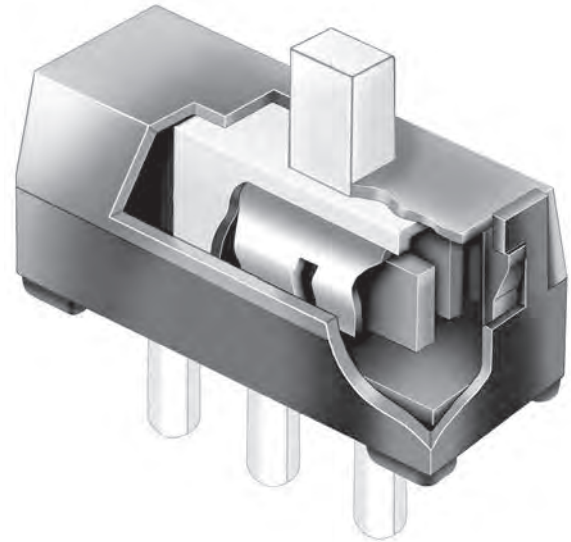

Actual Size

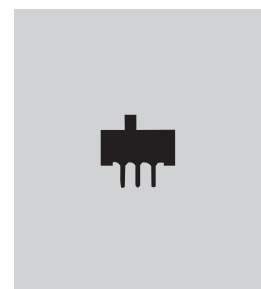

TYPICAL SWITCH ORDERING EXAMPLE

SS

12S

D

P

2

Poles & Circuits

12S	SPDT	ON	NONE	ON
SS12S model has shorting contacts.				
*14M	SP3T	ON	ON	ON
22S	DPDT	ON	NONE	ON
SS22S model has shorting contacts.				
See Poles & Circuits chart below.				
* 14M Circuit with silver contacts only.				

Terminal Spacing

B	Metric 2.0mm x 2.0mm
D	Inch .100" x .100"

Contact Material & Ratings

2	Silver Rated 0.1A @ 30V DC
*4	Gold Rated 0.4VA maximum @ 28V AC/DC maximum
* Gold not available with SS14M.	

Actuation

P	Top Actuated
H	Side Actuated

DESCRIPTION FOR TYPICAL ORDERING EXAMPLE

SS12SDP2

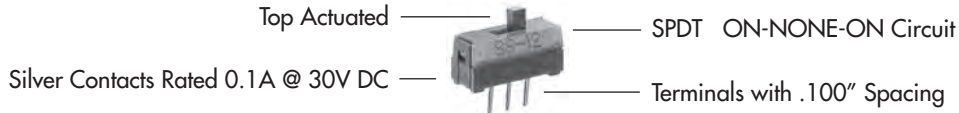

POLES & CIRCUITS

Pole	Model	Slide Position			Connected Terminals			Throw & Schematics
		Right	Center	Left	Right	Center	Left	
SP	SS12S	ON	NONE	ON	2-1	NONE	2-3	SPDT
SP	SS14M	ON	ON	ON	3-4	3-2	3-1	SP3T
DP	SS22S	ON	NONE	ON	2-1 5-4	NONE	2-3 5-6	DPDT

TERMINAL SPACING

B Metric 2.0mm x 2.0mm with Black Base

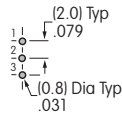
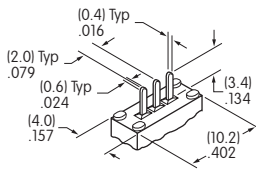

On-None-On Single Pole Models

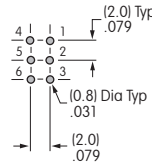
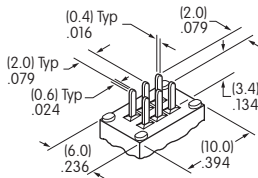

On-None-On Double Pole Models

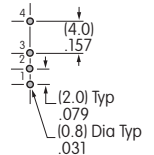
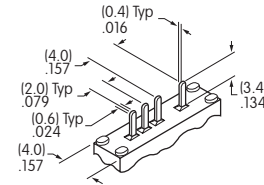

3-On Models

D Inch .100" x .100" with Gray Base

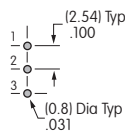
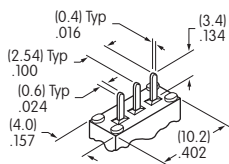

On-None-On Single Pole Models

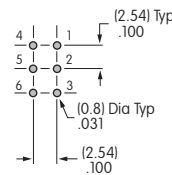
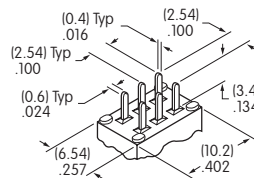

On-None-On Double Pole Models

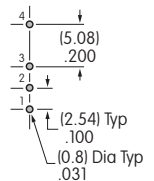
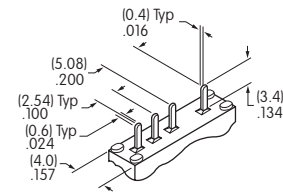

3-On Models

ACTUATION

P Top Actuated

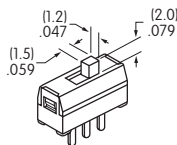

H Side Actuated

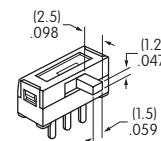

CONTACT MATERIALS & RATINGS

2 Silver over Phosphor Bronze

Power Level

0.1A @ 30V DC

4 Gold over Silver/Phosphor Bronze

Logic Level

0.4VA max @ 28V AC/DC max

Complete explanation of operating range in Supplement section.

TYPICAL SWITCH DIMENSIONS

Top Actuated

Single & Double Pole

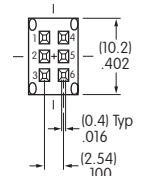
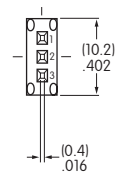
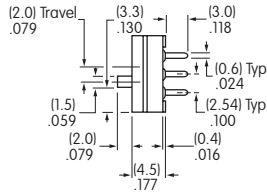
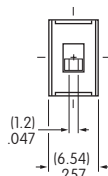
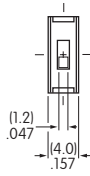

SS12SDP2

Side Actuated

Single & Double Pole

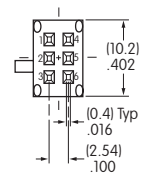
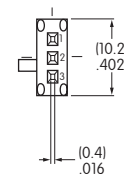
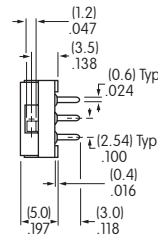
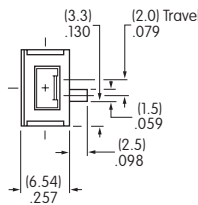
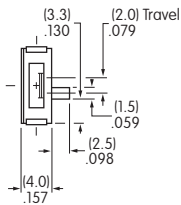

SS12SDH2

3-On Circuit • Top Actuated

Single Pole

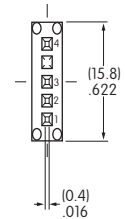
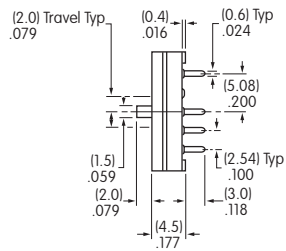
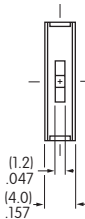

SS14MDP2

3-On Circuit • Side Actuated

Single Pole

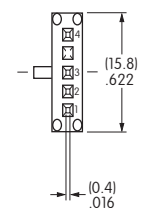
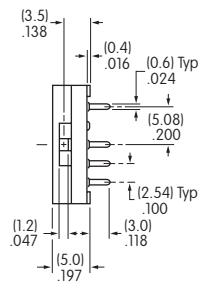
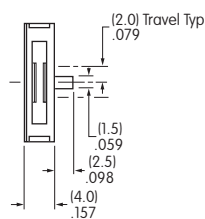

SS14MDH2

Distinctive Characteristics

Top or side actuation permits flexible board design.

Bright, LED illumination at tip of actuator.

Compact dimensions and low profile allow high density mounting and close stacking of PC boards.

Crisp actuation positively indicates circuit status.

Double molded thermoset base and thermoplastic housing prevent loosening of terminals due to high soldering temperatures.

Sliding twin contact mechanism with self-cleaning action provides smooth actuation and produces high contact reliability.

Insert molded terminals lock out flux, solvents, and other contaminants.

Inch terminal spacing for standard PC board grid (.100" x .100").

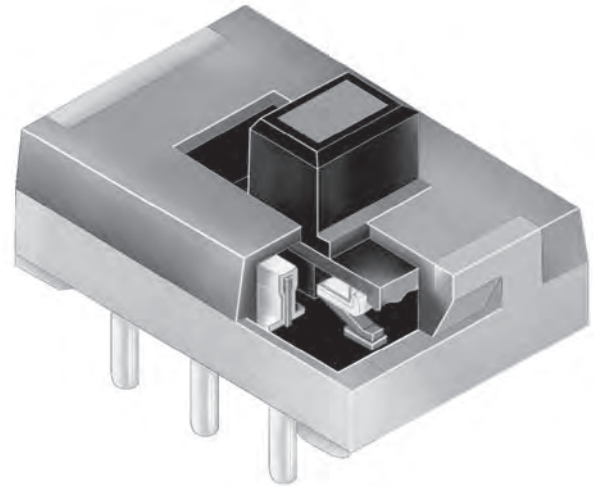

Actual Size

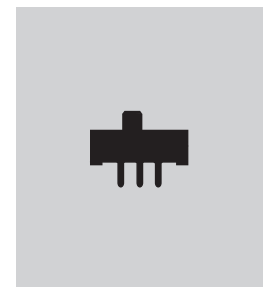

General Specifications

Electrical Capacity (Resistive Load)

Power Level: 0.1A @ 30V DC

Other Ratings

Contact Resistance: 20 milliohms maximum
Insulation Resistance: 100 megohms minimum @ 500V DC
Dielectric Strength: 500V AC minimum 1 minute minimum
Mechanical Life: 10,000 operations minimum
Electrical Life: 10,000 operations minimum
Contact Timing: Shorting (make-before-break)
Total Travel: .079" (2.0mm)

Materials & Finishes

Actuator: Polyacetal
Upper Case: Polyacetal
Lower Case: Glass fiber reinforced polyester
Movable Contactor: Phosphor bronze with silver plating
Interior Base: Phenolic resin (thermoset)
Terminals: Brass with silver plating over copper plating

Environmental Data

Operating Temp Range: -15°C through +60°C (+5°F through +140°F)
Humidity: 90 ~ 95% humidity for 96 hours @ 40°C (104°F)
Vibration: 10 ~ 55Hz with peak-to-peak amplitude of 1.5mm traversing the frequency range & returning in 1 minute; 3 right angled directions for 2 hours
Shock: 50G (490m/s²) acceleration (tested in 6 right angled directions, with 5 shocks in each direction)

PCB Processing

Soldering: Wave Soldering: For non-supported through-hole, see Profile B in Supplement section. For supported through-hole, 5 seconds maximum @ 250°C maximum.
 Manual Soldering: See Profile B in Supplement section.
Cleaning: These devices are not process sealed. Hand clean locally using alcohol based solution.

Standards & Certifications

The SS series devices have not been tested for UL recognition and CSA certification. These switches are designed for use in a low-voltage, low-current circuit. When used as intended in a low-voltage, low-current circuit, the results do not produce hazardous energy.

TYPICAL SWITCH ORDERING EXAMPLE

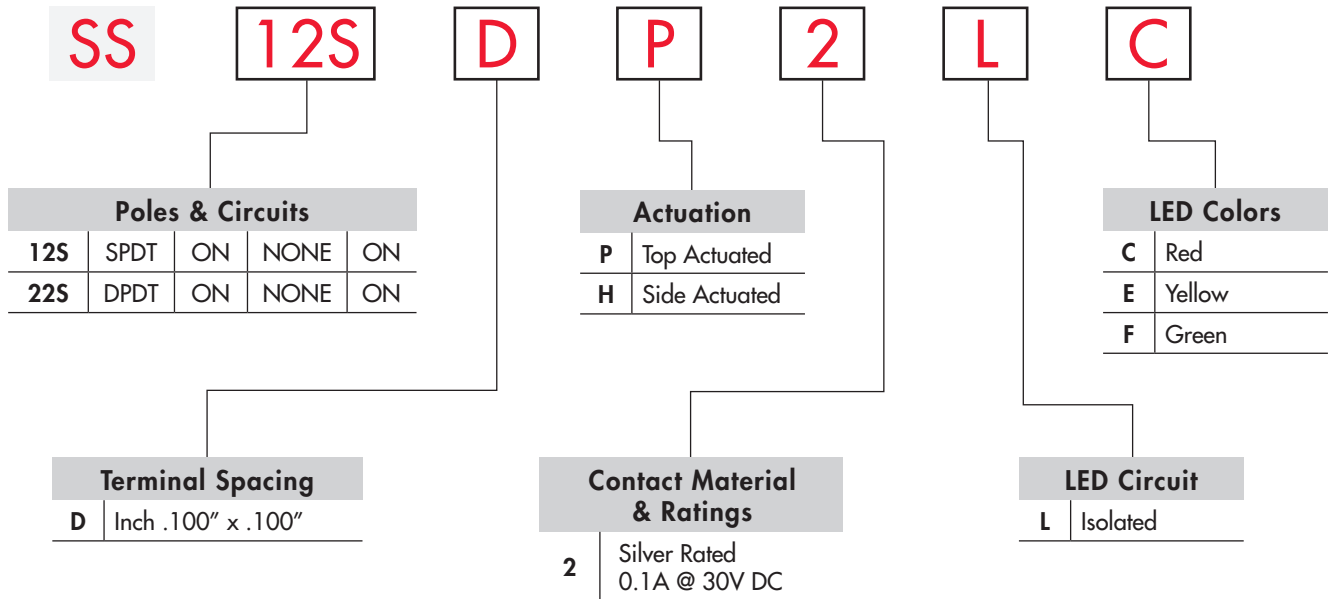

DESCRIPTION FOR TYPICAL ORDERING EXAMPLE

SS12SDP2LC

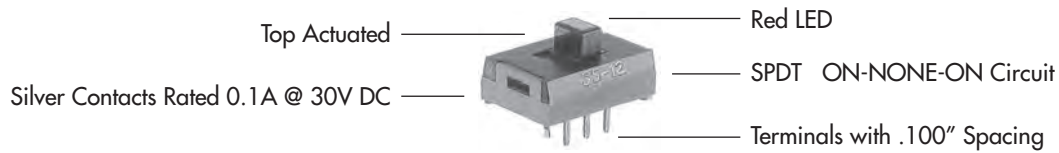

POLES & CIRCUITS

Pole	Model	Slide Position			Connected Terminals			Throw & Schematics
		Right	Center	Left	Right	Center	Left	
SP	SS12S	ON	NONE	ON	2-1	NONE	2-3	SPDT
DP	SS22S	ON	NONE	ON	2-1 5-4	NONE	2-3 5-6	DPDT

TERMINAL SPACING

D Inch .100" x .100"

Single Pole Models

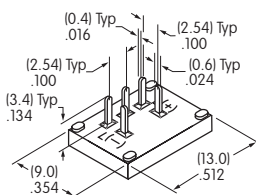

Double Pole Models

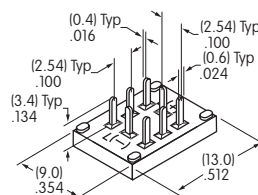

CONTACT MATERIALS & RATINGS

2

Silver over Phosphor Bronze

Power Level

0.1A @ 30V DC

TYPICAL SWITCH DIMENSIONS

Top Actuated

Single & Double Pole

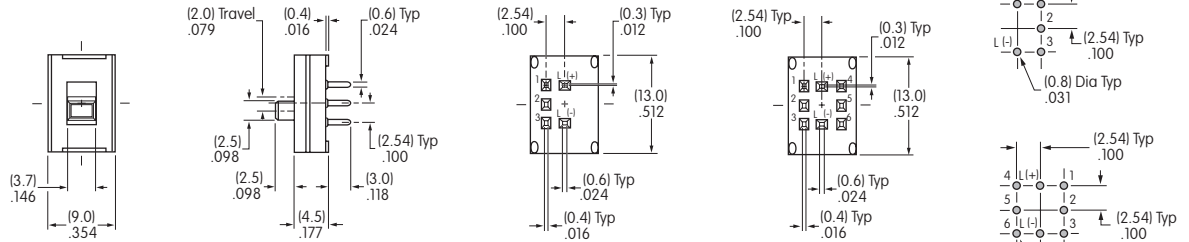

SS22SDP2LC

Side Actuated

Single & Double Pole

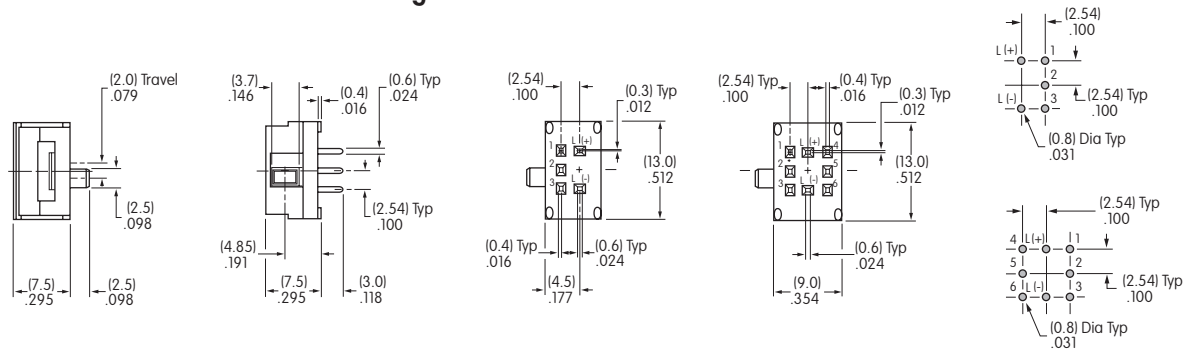

SS12SDH2LC

LED COLORS & SPECIFICATIONS

LEDs are supplied as an integral part of the switch (not available separately). The lamp circuit is independent of switch operation. Electrical specifications shown are determined at a basic temperature of 25°C.

If the source voltage exceeds the rated voltage, a ballast resistor is required. The resistor value can be calculated by using the formula given in the Supplement.

L Isolated, 1-element	Color	C	E	F
		Red	Yellow	Green
Maximum Forward Current	I_{FM}	30mA	30mA	25mA
Typical Forward Current	I_F	16mA	16mA	16mA
Forward Voltage	V_F	1.98V	2.06V	2.16V
Maximum Reverse Voltage	V_{RM}	5V	5V	5V
Current Reduction Rate Above 25°C	ΔI_F	0.40mA/°C	0.42mA/°C	0.33mA/°C
Ambient Temperature Range		-15° ~ +60°C		

OPTIONAL CAP

AT4065 Slide Cap

Material: Polycarbonate

Cap can be assembled on request

Cap Color: Black only

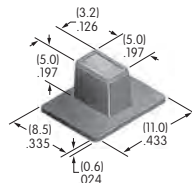

Window color should match LED color.

Colors Available:

C Red E Yellow F Green

Distinctive Characteristics

Compact dimensions and low profile allow high density mounting and close stacking of PC boards.

Crisp actuation positively indicates circuit status.

Heat resistant resin allows vapor phase and infrared convection reflow soldering.

Award-winning STC mechanism with benefits unavailable in conventional mechanisms: smoother, positive detent actuation, increased contact stability, and unparalleled logic-level reliability. (Additional STC details in Terms and Acronyms in the Supplement section.)

Insert molded terminals lock out flux, solvents, and other contaminants.

Metric terminal spacing for standard PC board grid (2.0mm x 2.0mm).

Gull-wing terminals provide mechanical stability during soldering and simplified solder joint inspection.

Packaged in tape-reel or partitioned tray. Tape-reel packaging meets EIA-481-D Standard.

Coplanarity: all considered surfaces must lie between two parallel planes that are a maximum distance apart of .0059" (0.15mm). (Additional coplanarity details in Terms and Acronyms in the Supplement section.)

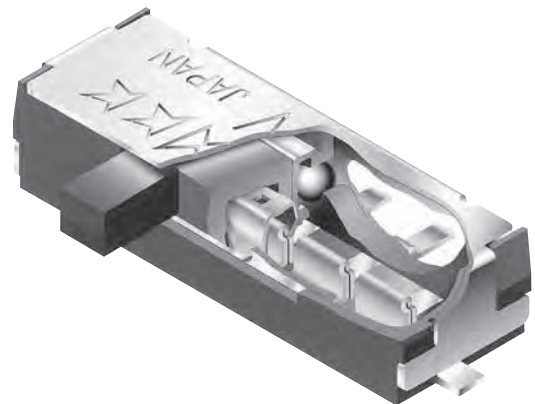

Actual Size

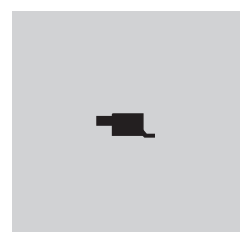

General Specifications

Toggles

Rockers

Pushbuttons

Illuminated PB

Programmable

Keylocks

Rotaries

Slides

Tactiles

Tilt

Touch

Indicators

Accessories

Supplement

Electrical Capacity (Resistive Load)

Logic Level: 0.4VA maximum @ 28V AC/DC maximum
(Applicable Range 0.1mA ~ 0.1A @ 20mV ~ 28V)
Note: Find additional explanation of operating range in Supplement section.

Other Ratings

Contact Resistance: 50 milliohms maximum
Insulation Resistance: 100 megohms minimum @ 500V DC
Dielectric Strength: 500V AC minimum for 1 minute minimum
Mechanical Life: 10,000 operations minimum
Electrical Life: 10,000 operations minimum
Contact Timing: SS312S ~ Shorting (make-before-break)
Total Travel: .079" (2.0mm)

Materials & Finishes

Actuator: Polyphenylene sulfide
Housing: Phosphor bronze with tin plating (UL94V-0)
Base: Polyphenylene sulfide (UL94V-0)
Movable Contactor: Phosphor bronze with gold plating over silver plating (code 4)
Terminals: Phosphor bronze with gold plating

Environmental Data

Operating Temp Range: -25°C through +85°C (-13°F through +185°F)
Humidity: 90 ~ 95% humidity for 240 hours @ 40°C (104°F)
Vibration: 10 ~ 55Hz with peak-to-peak amplitude of 1.5mm traversing the frequency range & returning in 1 minute; 3 right angled directions for 2 hours
Shock: 50G (490m/s²) acceleration (tested in 6 right angled directions, with 5 shocks in each direction)

Installation

Soldering: Reflow Soldering Recommended. See Profile A in Supplement section.
Manual Soldering: See Profile A in Supplement section.
Cleaning: These devices are not process sealed. Hand clean locally using alcohol based solution.

Standards & Certifications

Flammability Standards: UL 94V-0 rated housing & base
The SS3 Series slides have not been tested for UL recognition or CSA certification.
These switches are designed for use in a low-voltage, low-current, logic-level circuit.
When used as intended in a logic-level circuit, the results do not produce hazardous energy.

TYPICAL SWITCH ORDERING EXAMPLE

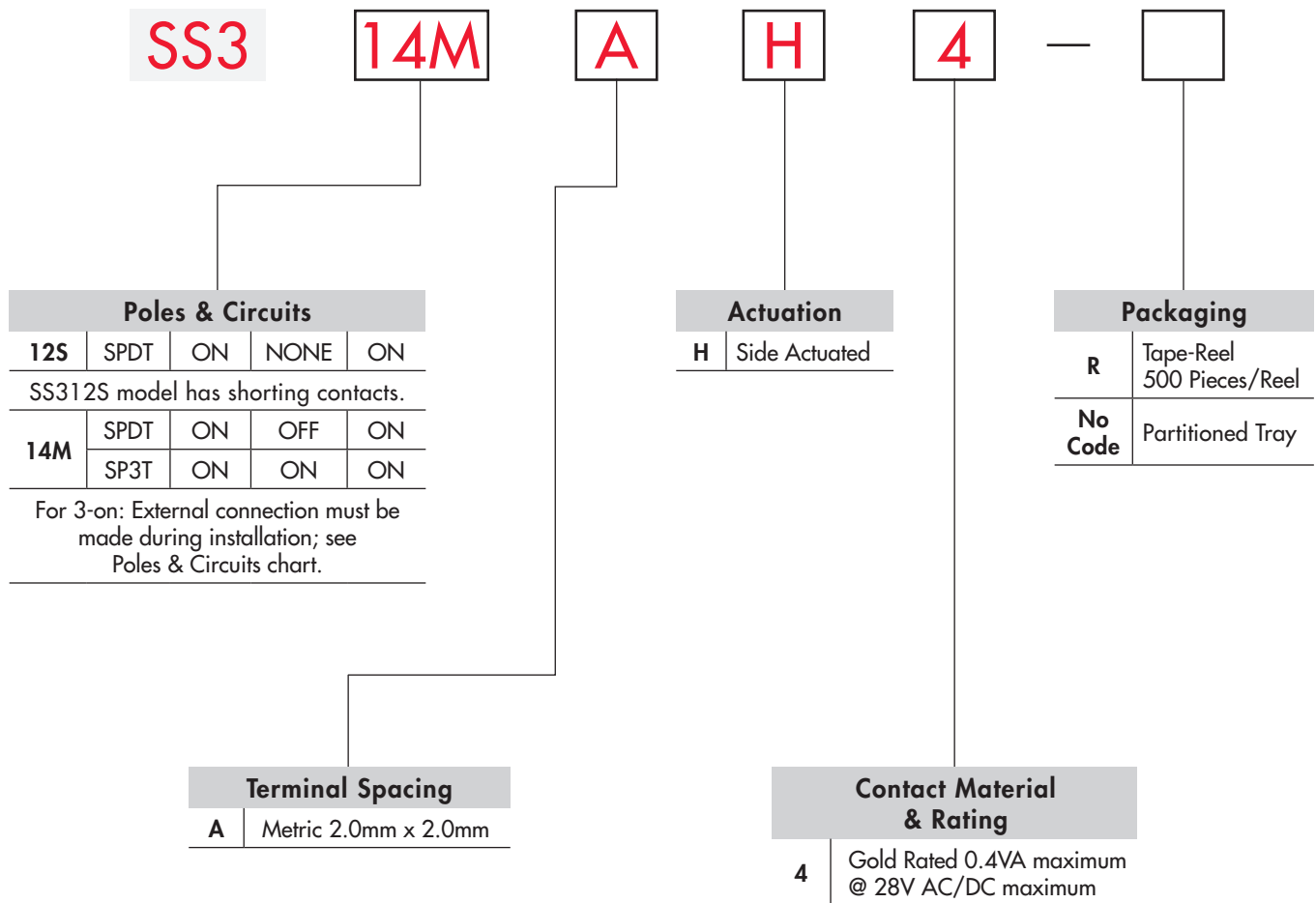

DESCRIPTION FOR TYPICAL ORDERING EXAMPLE

SS314MAH4



Toggles

Rockers

Pushbuttons

Illuminated PB

Programmable

Keylocks

Rotaries

Slides

Tactiles

Tilt

Touch

Indicators

Accessories

Supplement

POLES & CIRCUITS

		Slide Position			Connected Terminals			Throw & Schematics	
Pole	Model	Right	Center	Left	Right	Center	Left	Note: Terminal numbers are not actually on switch.	
SP	SS312S							SPDT	
SP	SS314M							SPDT	
								SP3T	 External Connection External connection must be made during installation to create ON-ON-ON circuit.

TERMINAL SPACING

A Metric 2.0mm x 2.0mm

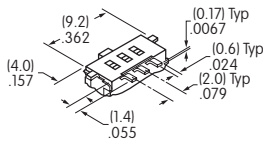

SS312

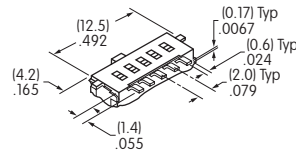
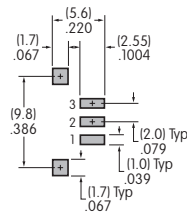

SS314

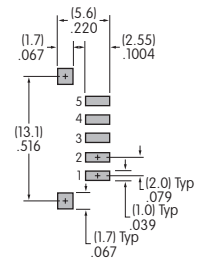

ACTUATION

H Side Actuated

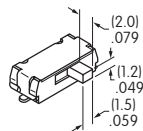

CONTACT MATERIALS & RATING

4 Gold over Silver/Phosphor Bronze Logic Level 0.4VA maximum @ 28V AC/DC maximum

Complete explanation of operating range in Supplement section.

TYPICAL SWITCH DIMENSIONS

Shorting Contacts

Single Pole

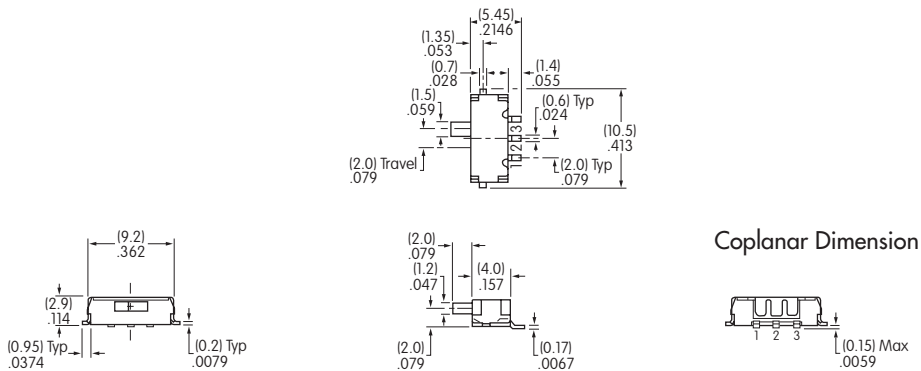

SS312SAH4

Nonshorting Contacts

Single Pole

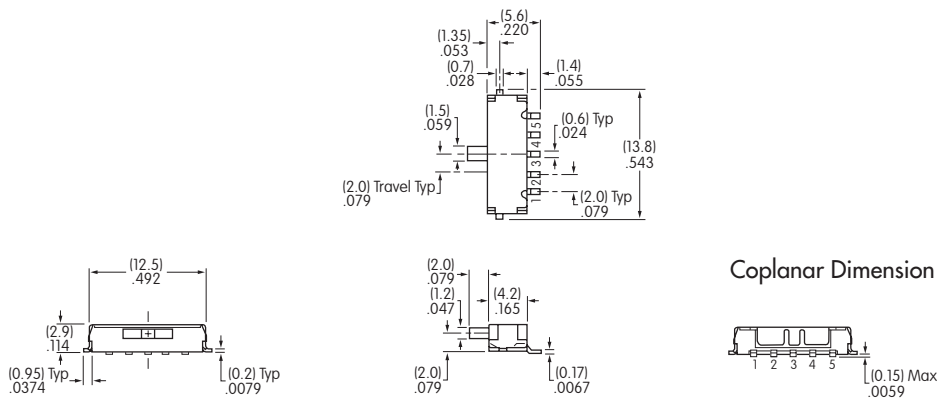

SS314MAH4

PACKAGING

No Code

Partitioned Tray

If the SS3 is ordered in less than 500-piece increments, the switches are packaged in a partitioned tray. No code is required.



PACKAGING

R

Tape-Reel Packaging

Switches must be ordered in 500-piece increments when tape-reel packaging is selected.

Tape-reel packaging meets EIA-481-D Standard.

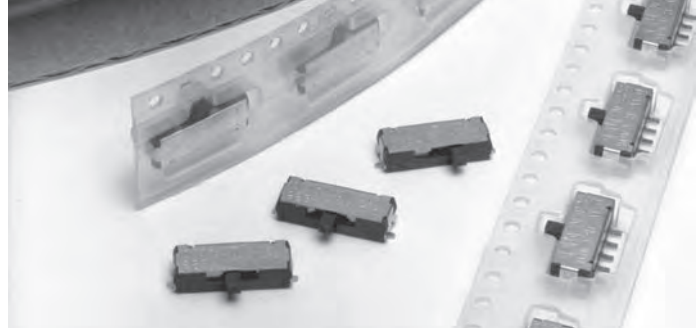

Tape-Reel Packaging for SS312SAH4

Each tape-reel of 530 pockets contains 500 switches.

Minimum Leader Length: 11.97" (304mm) Minimum Trailer Length: 6.93" (176mm)

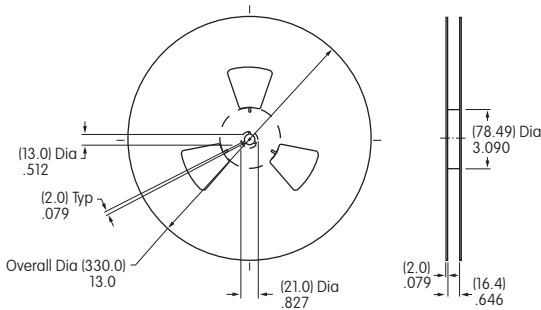

Reel Dimensions

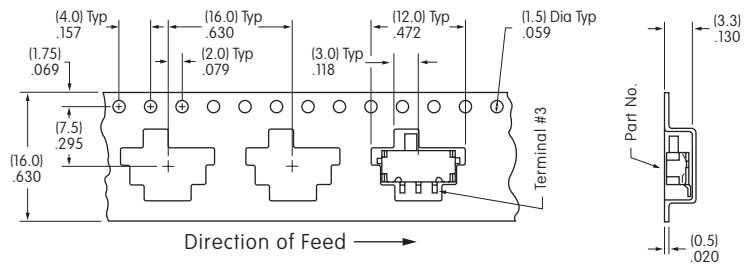

Tape Dimensions

Tape-Reel Packaging for SS314MAH4

Each tape-reel of 530 pockets contains 500 switches.

Minimum Leader Length: 14.96" (380mm) Minimum Trailer Length: 8.66" (220mm)

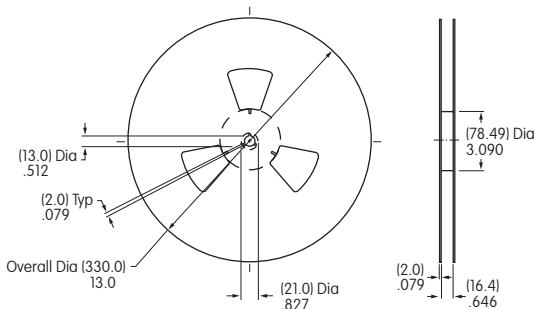

Reel Dimensions

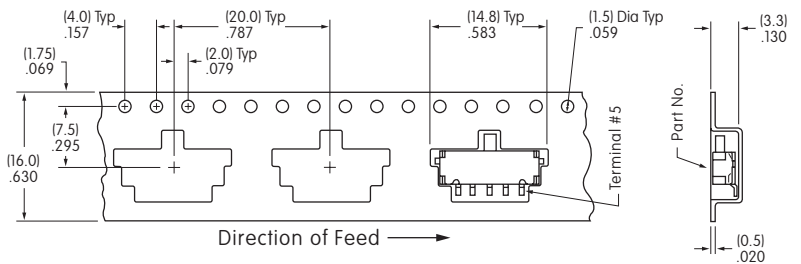

Tape Dimensions



NKK Switches

Over 65 Years of Innovation

NKK Switches is known throughout the world as the industry leader of electromechanical switches and manufacturer of the widest range of illuminated, process sealed, miniature, specialty, surface mount and programmable switches. With over 3.5 million switch options, all products are designed with innovation, high reliability, customization and a commitment to excellence.

NKK's sales and engineering teams are dedicated to providing technical expertise and outstanding customer support.

Our manufacturing centers are ISO 9001 and ISO 14001 certified and feature state-of-the-art production and testing facilities to assure the highest quality products.

Please visit www.nkkswitches.com for NKK Sales Representatives and Distributors in your area.



NIKK
SWITCHES

www.nkkswitches.com

Available Worldwide

Over 65 Years of Engineering Excellence

- ▶ Design and Manufacturing of All Products
- ▶ Widest Selection of Electromechanical Switches in the Industry
- ▶ Free Online 3D CAD Models with over 500,000 Product Variations
- ▶ Custom Products for Specific Applications
- ▶ High Quality and Environmentally Safe Products (RoHS, REACH)
- ▶ ISO Certified Facilities



Warranty: All NKK products are warranted against defects in workmanship, material and construction for a period of one (1) year from the date of shipment if the products have been properly installed, used, and maintained. There are no express warranties of merchantability or fitness for a particular purpose. Materials, finishes, and component parts are subject to change without notification.



Corporate Headquarters

NKK SWITCHES CO., LTD.

Kawasaki-shi, Japan

Tel: 81.44.813.8001 / Fax: 81.44.813.8031

www.nkkswitches.co.jp

Global Offices:

Americas

NKK SWITCHES OF AMERICA, INC.

Scottsdale, AZ USA

Tel: 1.480.991.0942 / Fax: 1.480.998.1435

www.nkkswitches.com

Asia

NKK SWITCHES HONG KONG CO., LTD.

Kwai Chung, N.T., Hong Kong

Tel: 852.2366.6634 / Fax: 852.2366.6803

www.nkkswitches.com.hk

China

NKK SWITCHES CHINA, CO., LTD.

Shanghai, China

Tel: 86.21.6249.6574 / Fax: 86.21.6248.3375

www.nkkswitches.com.cn

Europe

NKK SWITCHES CO., LTD.

Frankfurt, Germany

Tel: 49.61.96.400.187 (English) / 49.61.96.400.189 (Deutsch)

www.nkkswitches.eu